

# **axist**

***Aluminium tilt & turn systems***

®

ALUMINIUM & GLASS RAILING SYSTEMS

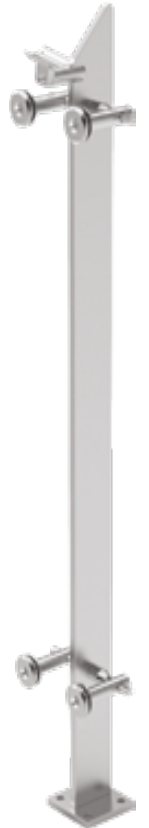





# ÜRETİM

## ALUMİNYUM KORKULUK SİSTEMLERİ;

Tecrübe ve bilgisiyle, CNC işlem kalitesi ve eloksal kaplamada mikron kalitesinden asla taviz vermeden üretimlerine yön veren firmamız, kendi sektöründe başarılarla dolu yılları geride bırakmış, bu gelişiminin bir sonucu olarak üretim planlama, pazarlama, satış ve satış sonrası hizmetler başlığında ülkemizin sayılı firmaları arasında yerini almış bulunmaktadır. Ayrıca dizayn tasarım ofisleri ile tüm tasarımlarını müşteri beklentilerine uygun olarak kendi bünyesinde tamamlayan firmamızın kullanmış olduğu Ekstrüzyon alüminyum profiller, 6063 seri biletlerden, ISO VE TSE kalitesinde üretilmekte, bu sayede en kaliteli ürünler en olması gereken şekliyle müşterilerimize sunulmaktadır.

Pazarlama faaliyetlerinede yoğun bir biçimde devam eden, ASYA, AVRUPA, AFRIKA VE ORTADOĞU BÖLGESİNDE dünyanın birçok ülkesine ihracat yapan firmamız, bu gelişimini müşterileriyle paylaşarak daha da ileri götürme hedefindedir.





# PRODUCTION

## ALUMINYUM RAILING SYSTEMS;

Our company, which considers its productions without compromising an micron quality in CNC processing quality and anodized coating with its experience and knowledge, has left successful years behind in its sector, and as a result of this development, it has taken its place among the few companies of our country in the title of production planning, marketing, sales and after-sales services. In addition, extrusion aluminum profiles used BY our company, which completes all its designs in accordance with customer expectations with its design offices, are produced from 6063 serial billets in ISO and TSE quality, so that the highest quality products are offered to our customers as they should be.

Continuing its marketing activities intensively, our company and exporting to many countries of the world in ASIA, EUROPE, AFRICA and the MIDDLE EAST REGION, our company aims is to take this development further by sharing it with its clients.





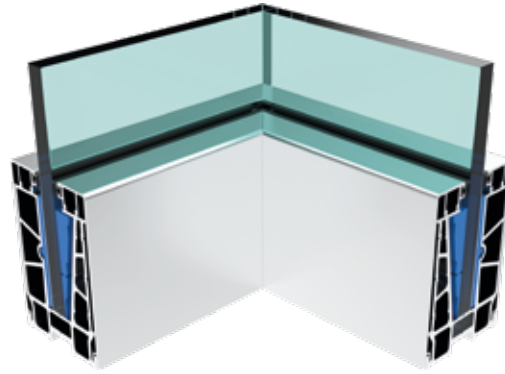

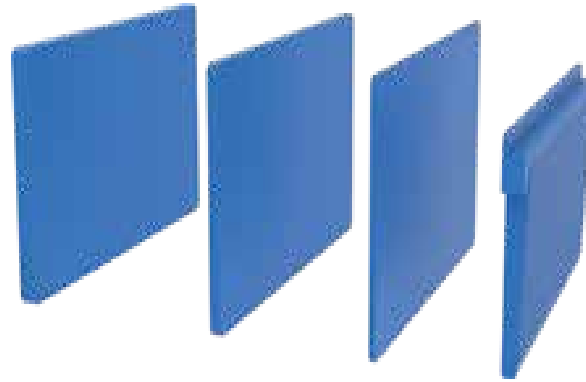
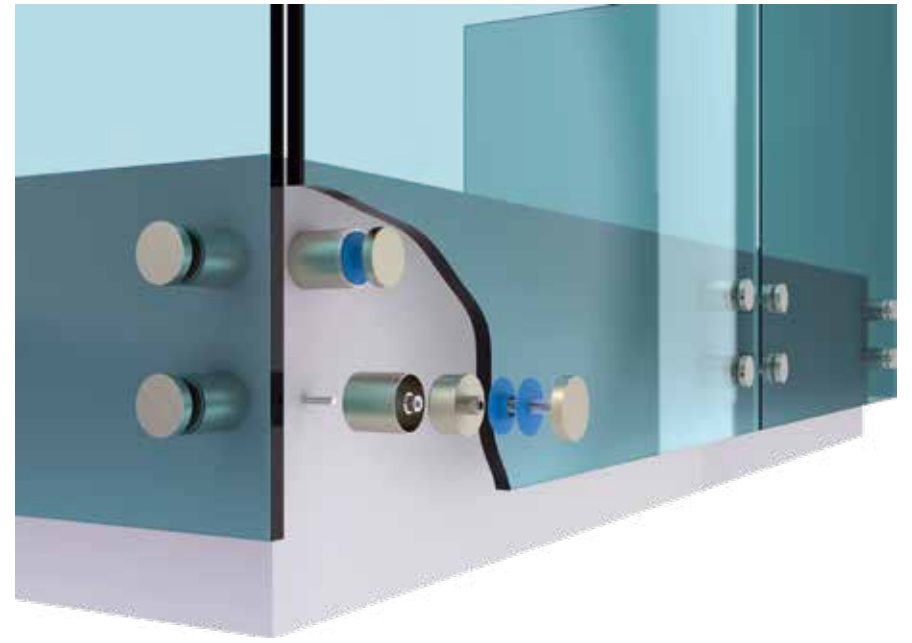

# AS87 CAM BAZA SİSTEMİ

## AS87 GLASS BASE SYSTEM

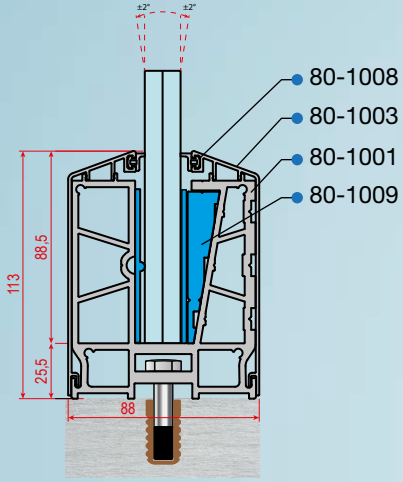

AS87 SERİSİ sağlamlığın yanı sıra mekanlarınıza estetik ve modern bir görünüm katar. Aynı zamanda seyir zevkini mükemmelliyete ulaştırır.

Ayarlanabilir özelliği ile her bir cam paneli dikeyden 2° sağ veya sol yana ince ayar yapabilme özelliğine sahiptir.

*AS87 SERIES adds an aesthetic and modern look to your spaces as well as being robust. At the same time, it brings the viewing pleasure to perfection.*

*With its adjustable feature, each glass panel has the ability to fine-tune 2 degrees from the vertical to the right or left.*

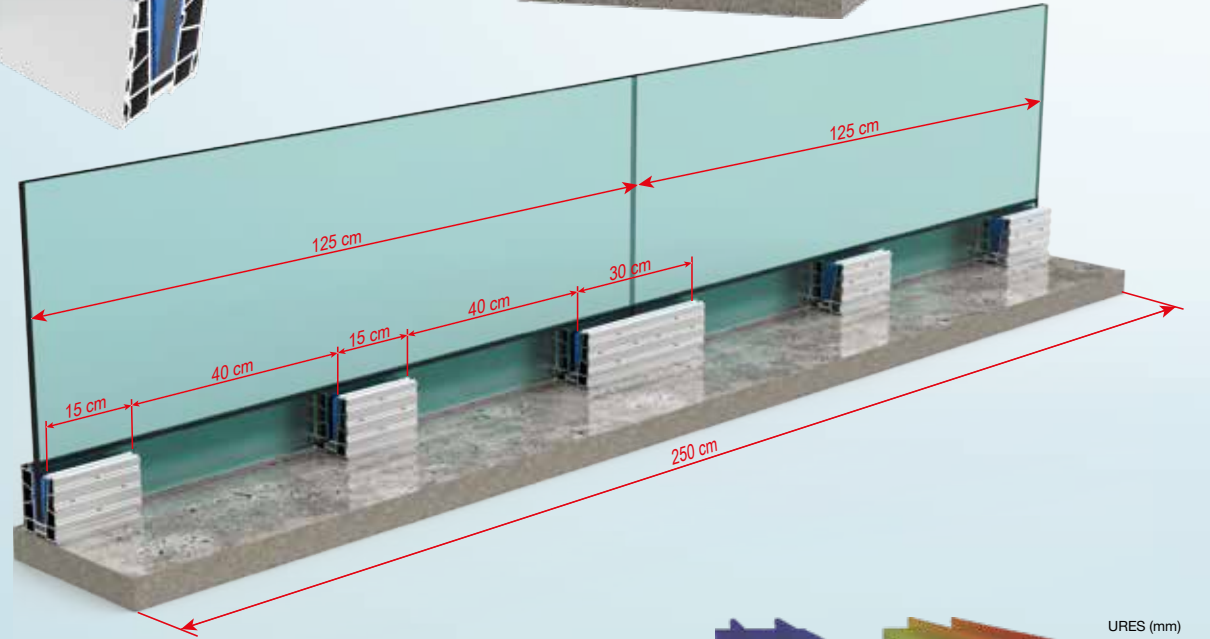
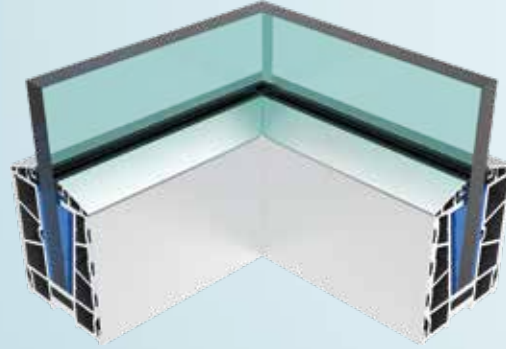

Alternatifli cam seçenekleri ile geniş bir kullanım sağlamaktadır.  
*It provides a wide usage with alternative glass options.*

Cam Glass (mm)	AS87 Serisi Cam Özellikleri AS87 Series Glass Features				
Kalınlık Thickness	8	5+5	6+6	8+8	10+10
Uzunluk Length	1500	2000	1750	1500	1250
Yükseklik Height	900	1000	1150	1250	1500



**TS498 , DIN 1055** standartlarına göre yapılan yüklemeler ve **AA-ASD-2000 Alüminyum design code standartları** ile yapılan hesaplama raporları ve testleri sonucu

Baza için çizgisel Gcam Hesabı

**(48,6 kg / metre) x 6,7 metre / 2,4 metre = 135,67 kg/mt**

Yapılan statik analiz sonucuna göre max sehim şartı sağlanmıştır  
max sehim baza **0,80 mm**  
max sehim cam **11,2 mm** olarak hesaplanmıştır.

According to the Loads standards **TS498, DIN 1055** , and **AA-ASD-2000 Aluminum design code standards**  
The result of calculation reports and tests made with

Linear Gcam Calculation for the Base:

**(48.6 kg / meter) x 6,7 meters / 2,4 meters = 135,67 kg/m**

According to the results of the static analysis, the maximum deflection condition was met.  
The max deflection of the base is **0.80 mm**  
The maximum deflection of the glass is calculated as **11,2 mm**.

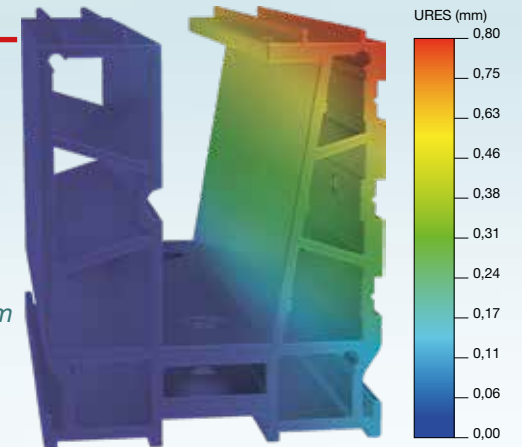



# AS87 Serisi

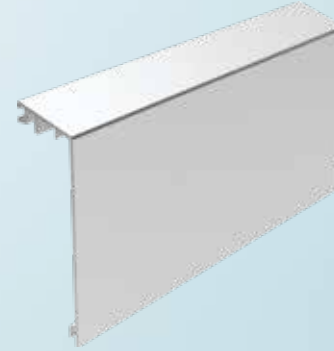
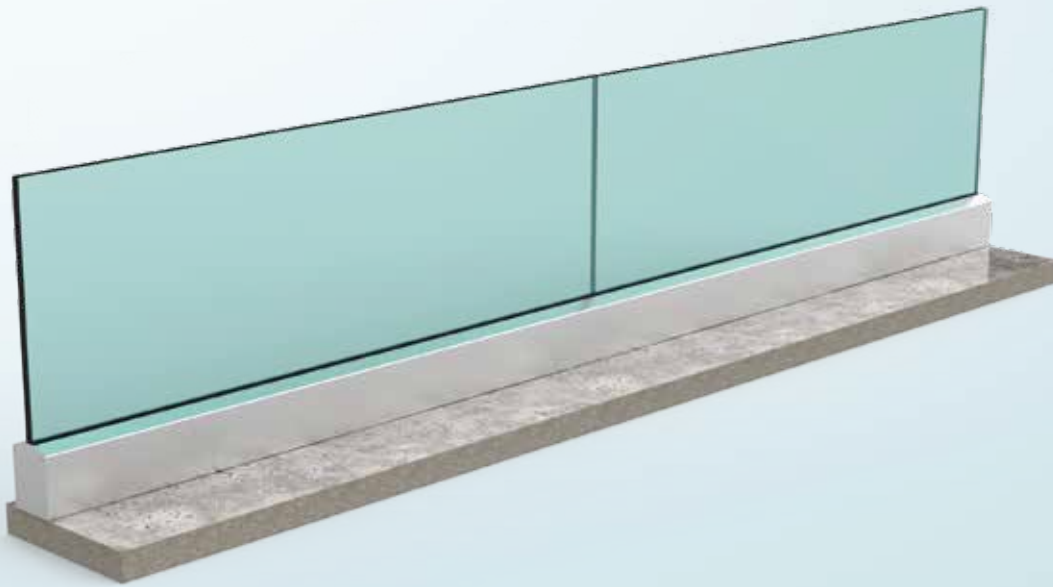

80-1003

KAPAK PROFİLİ  
PROFILE COVER

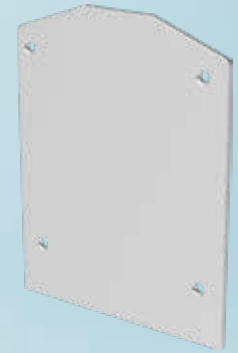

80-1004

BITİŞ KAPAĞI  
SIDE COVER

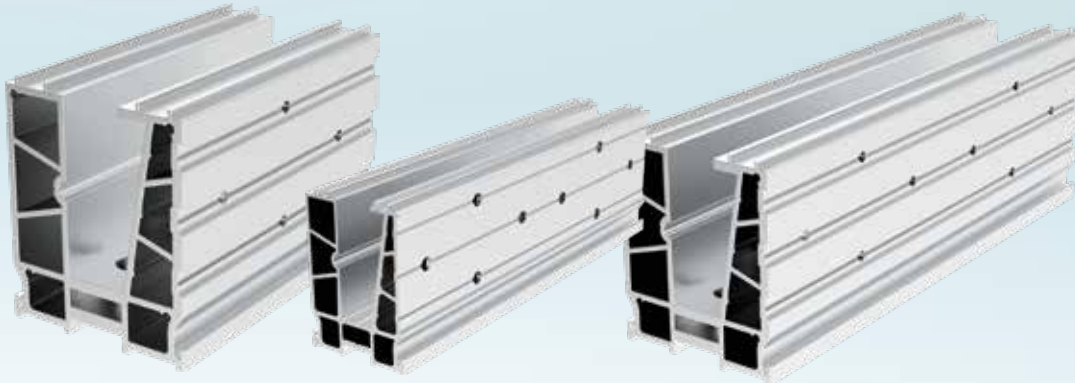

80-1001

CAM BAZA 15 cm  
GLASS BASE 15 cm

80-1002

CAM BAZA 30 cm  
GLASS BASE 30 cm



80-1012

CAM BAZA KÖŞE  
GLASS BASE CORNER

# AS20 CAM BAZA SİSTEMİ

## AS20 GLASS BASE SYSTEM

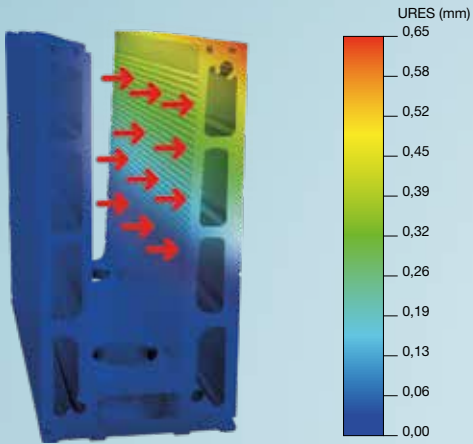

**TS498 , DIN 1055** standartlarına göre yapılan yüklemeler ve **AA-ASD-2000 Alüminyum design code standartları** ile yapılan hesaplama raporları ve testleri sonucu

Baza için çizgisel Gcam Hesabı

$$(48,6 \text{ kg / metre}) \times 4,2 \text{ metre} / 1,2 \text{ metre} = 170,1 \text{ kg/mt}$$

Yapılan statik analiz sonucuna göre max sehim şartı sağlanmıştır  
max sehim baza **0,65 mm**  
max sehim cam **8,425 mm** olarak hesaplanmıştır.

According to the Loads standards **TS498, DIN 1055** , and **AA-ASD-2000 Aluminum design code standards**  
The result of calculation reports and tests made with

Linear Gcam Calculation for the Base:

$$(48.6 \text{ kg / meter}) \times 4.2 \text{ meters} / 1.2 \text{ meters} = 170.1 \text{ kg/m}$$

According to the results of the static analysis, the maximum deflection condition was met.  
The max deflection of the base is **0.65 mm**  
The maximum deflection of the glass is calculated as **8,425 mm**.

Uygulanan Güç = 1.700 Newton  
1 Newton = 0,101 Kg



- Cam üstü zengin profil seçeneği,
- Yüksek camlarda maximum güvenlik,
- Modüler tasarım ile hızlı montaj,
- Modern yapılara alternatif tasarımlar

- Many profile option on glass,
- Maximum safety in high windows,
- Fast assembly with modular design,
- Alternative designs to modern structures

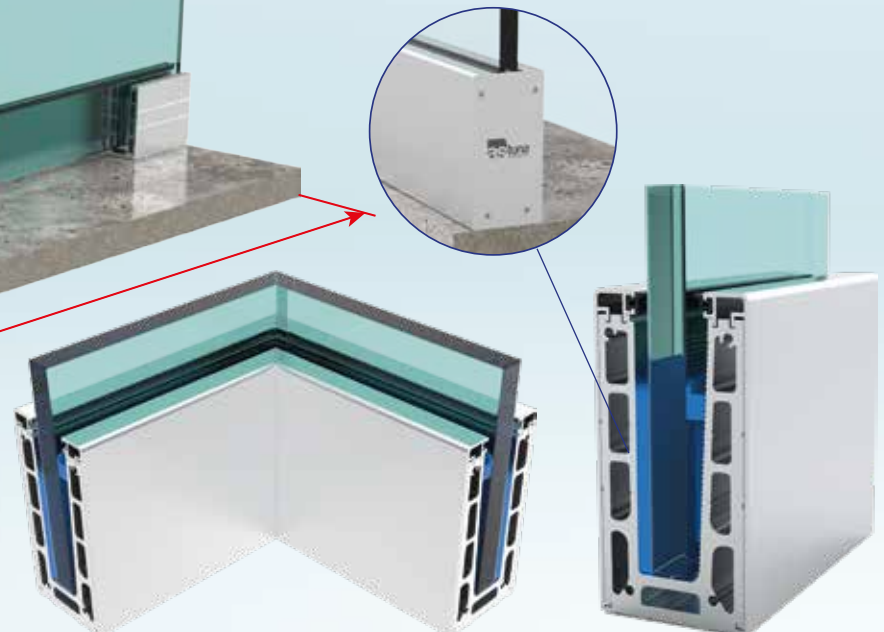
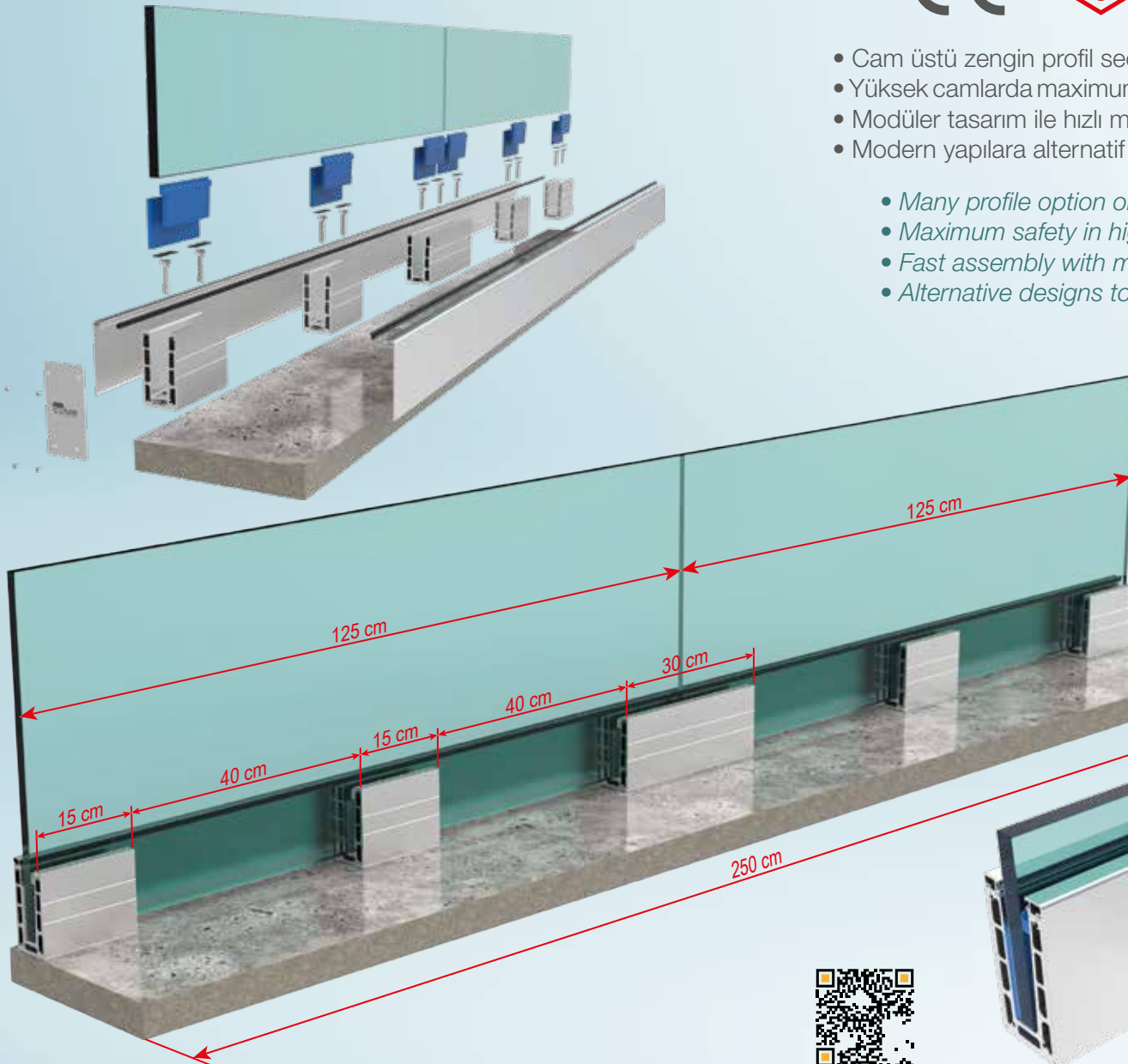
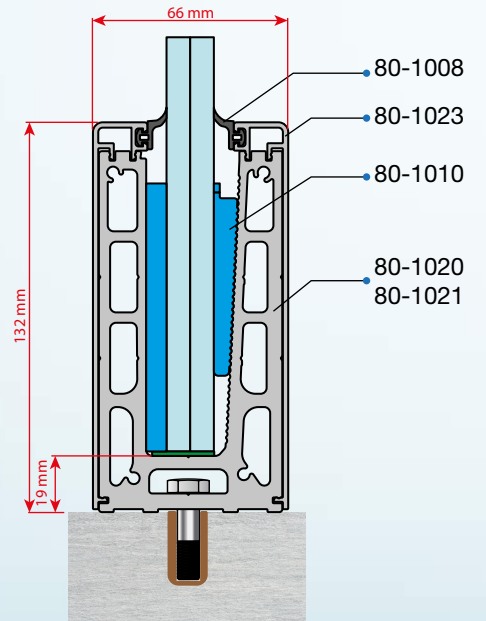





AS20 Cam baza sistemi, eşsiz manzara keyfi ve güvenliğinizi düşünülerek tasarlanmıştır.

AS20 Glass base system has been designed with your unique view pleasure and safety in mind.

Alternatifi cam seçenekleri ile geniş bir kullanım sağlamaktadır.

It provides a wide usage with alternative glass options.

Cam Glass (mm)	AS20 Serisi Cam Özellikleri AS20 Series Glass Features			
Kalınlık Thickness	5+5	6+6	8+8	10+10
Uzunluk Length	2000	1750	1500	1250
Yükseklik Height	1000	1150	1250	1500



80-1020

CAM BAZA 15 cm  
GLASS BASE 15 cm

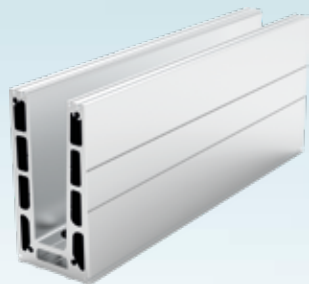

80-1021

CAM BAZA 30 cm  
GLASS BASE 30 cm



80-1022

CAM BAZA KÖŞE  
GLASS BASE CORNER

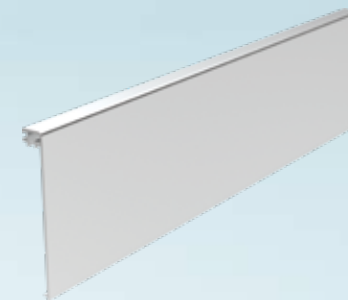

80-1023

KAPAK PROFİLİ  
PROFILE COVER



80-1024

BİTİŞ KAPAĞI  
SIDE COVER

# E42 CAM BAZA SİSTEMİ

## E42 GLASS BASE SYSTEM

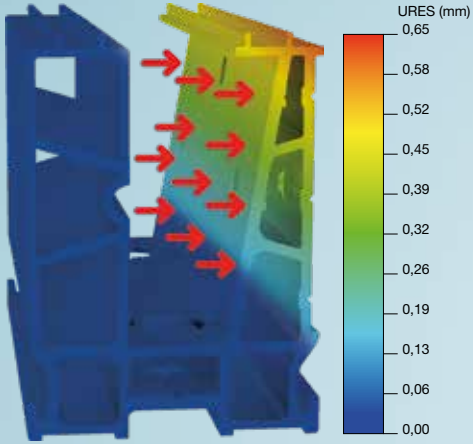

Uygulanan Güç = 1.700 Newton  
1 Newton = 0,101 Kg

**TS498 , DIN 1055** standartlarına göre yapılan yüklemeler ve **AA-ASD-2000 Alüminyum design code standartları** ile yapılan hesaplama raporları ve testleri sonucu

Baza için çizgisel Gcam Hesabı

$$(48,6 \text{ kg / metre}) \times 6,7 \text{ metre} / 2,4 \text{ metre} = 135 \text{ kg/mt}$$

Yapılan statik analiz sonucuna göre max sehım şartı sağlanmıştır  
max sehım baza **0,50 mm**  
max sehım cam **6,30 mm** olarak hesaplanmıştır.

According to the Loads standards **TS498, DIN 1055** , and **AA-ASD-2000 Aluminum design code standards**  
The result of calculation reports and tests made with

Linear Gcam Calculation for the Base:

$$(48.6 \text{ kg / meter}) \times 6.7 \text{ meters} / 2.4 \text{ meters} = 135 \text{ kg/m}$$

According to the results of the static analysis, the maximum deflection condition was met.  
The max deflection of the base is **0,50 mm**  
The maximum deflection of the glass is calculated as **6,30 mm**.



- Cam üstü zengin profil seçeneği,
- Modüler tasarım ile hızlı montaj,
- Modern yapılara alternatif tasarımlar

- Many profile option on glass,
- Fast assembly with modular design,
- Alternative designs to modern structures

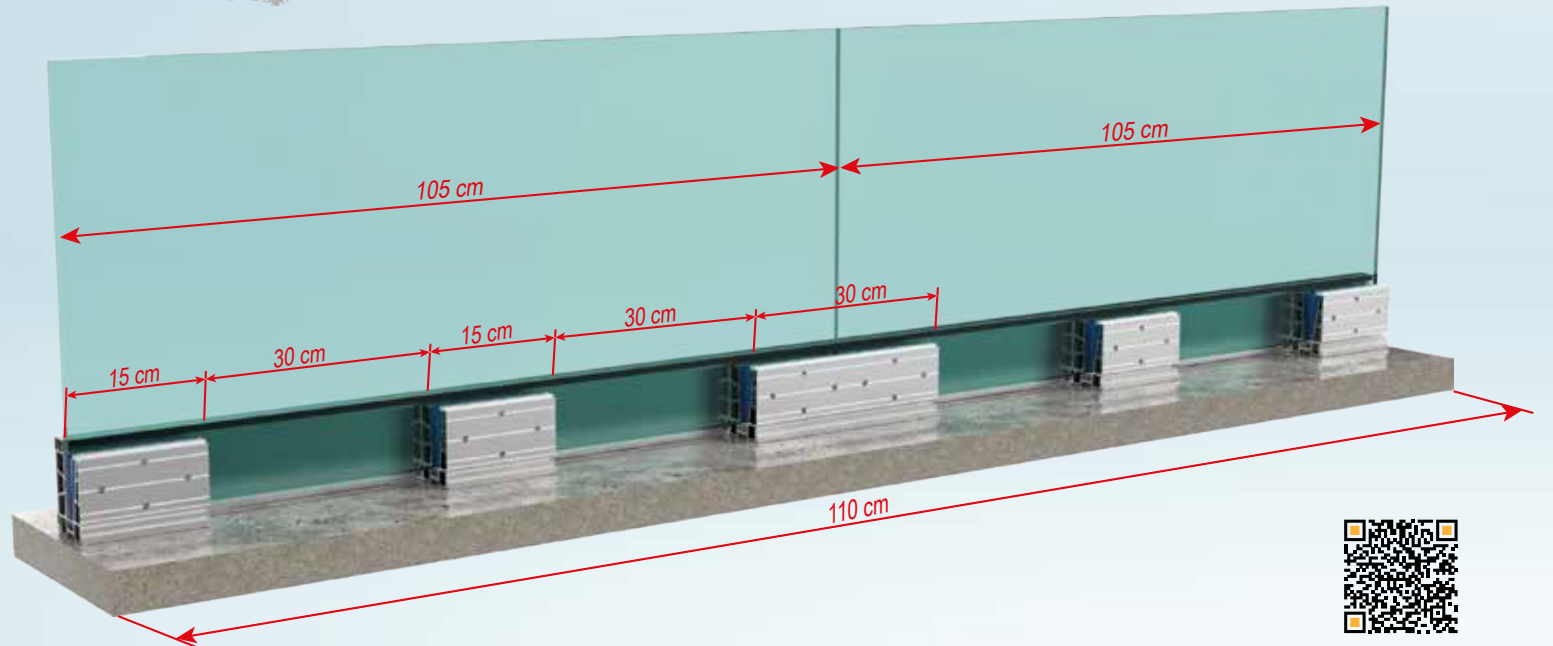
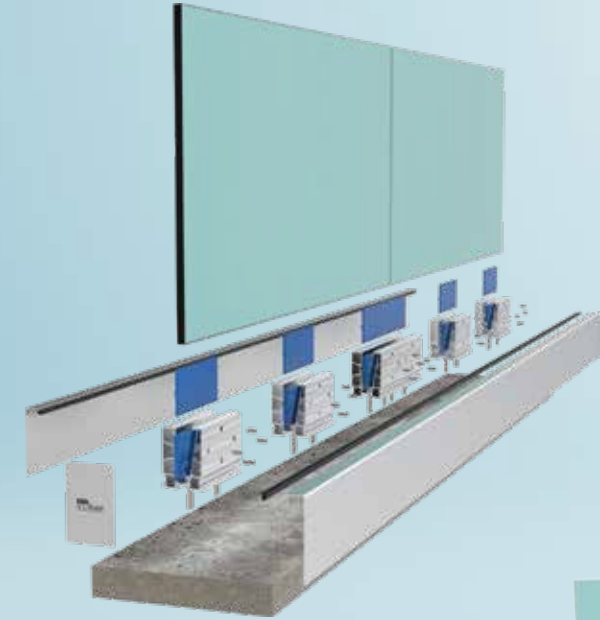
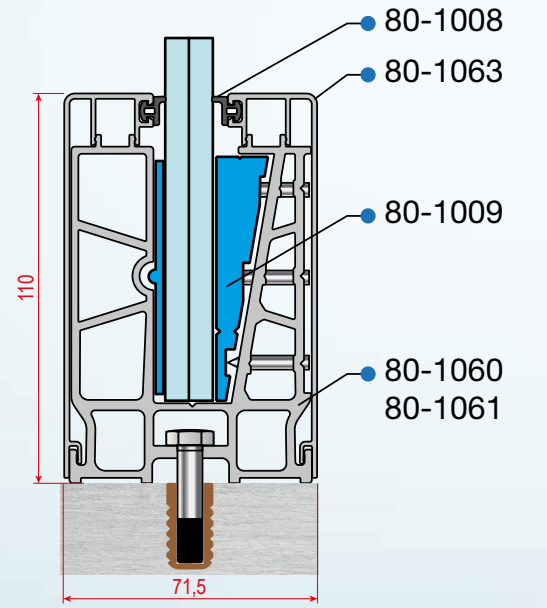



E42 Cam baza sistemi, parafet ve duvar üstü montaj kolaylığı sağlar.

E42 Glass plinth system provides ease of mounting on parapet and wall.

Cam Glass (mm)	AS20 Serisi Cam Özellikleri AS20 Series Glass Features	
Kalınlık Thickness	5+5	6+6
Uzunluk Length	2000	1750
Yükseklik Height	1000	1150

Alternatifli cam seçenekleri ile geniş bir kullanım sağlamaktadır.

It provides a wide usage with alternative glass options.



80-1060

CAM BAZA 15 cm  
GLASS BASE 15 cm



80-1061

CAM BAZA 30 cm  
GLASS BASE 30 cm



80-1062

CAM BAZA KÖŞE  
GLASS BASE CORNER

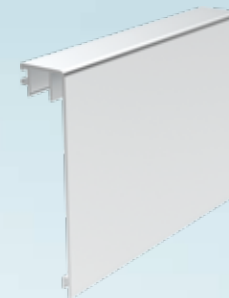

80-1063

KAPAK PROFİLİ  
PROFILE COVER



80-1064

BİTİŞ KAPAĞI  
SIDE COVER



# D11 CAM BAZA SİSTEMİ

## D11 GLASS BASE SYSTEM



metal & alüminyum

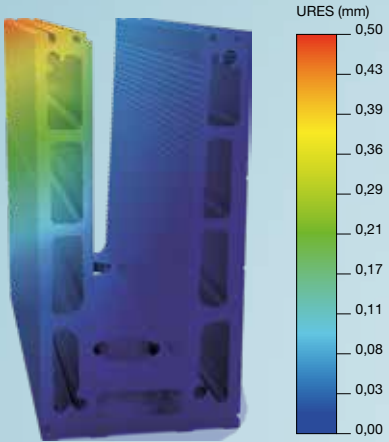

Uygulanan Güç = 1.700 Newton  
1 Newton = 0,101 Kg

**TS498 , DIN 1055** standartlarına göre yapılan yüklemeler ve **AA-ASD-2000 Alüminyum design code** standartları ile yapılan hesaplama raporları ve testleri sonucu

Baza için çizgisel Gcam Hesabı

$(48,6 \text{ kg / metre}) \times 4,2 \text{ metre} / 1,2 \text{ metre} = 170,1 \text{ kg/mt}$

Yapılan statik analiz sonucuna göre max sehim şartı sağlanmıştır  
max sehim baza **0,50 mm**  
max sehim cam **8,425 mm** olarak hesaplanmıştır.

According to the Loads standards **TS498, DIN 1055** , and **AA-ASD-2000 Aluminum design code standards**  
The result of calculation reports and tests made with

Linear Gcam Calculation for the Base:

$(48.6 \text{ kg / meter}) \times 4.2 \text{ meters} / 1.2 \text{ meters} = 170.1 \text{ kg/m}$

According to the results of the static analysis, the maximum deflection condition was met.  
The max deflection of the base is **0.50 mm**  
The maximum deflection of the glass is calculated as **8,425 mm**.

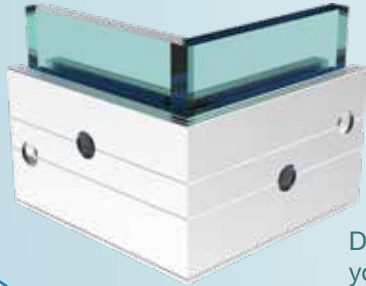

D11 Cam baza sistemi yapılarınızın birçok alanında kullanılarak estetik bir görünüm sağlar. Uzman ekibimiz tarafından tasarlanan D11 sistemi, maksimum güvenlik düşünülerek manzaranın keyfini yaşayacağınız şekilde üretilmiştir.

D11 Glass base system provides an aesthetic appearance by using it in many areas of your buildings. Designed by our expert team the D11 system has been produced in such a way that you can enjoy the view with maximum safety in mind.

- Genişletilmiş alan avantajı,
- Yüksek camlarda maximum güvenlik,
- Estetik görsel bütünlüğü,
- Modern yapılara alternatif tasarımlar
- Expanded area advantage,
- Maximum safety in high windows,
- Aesthetic visual integrity,
- Alternative designs to modern structures

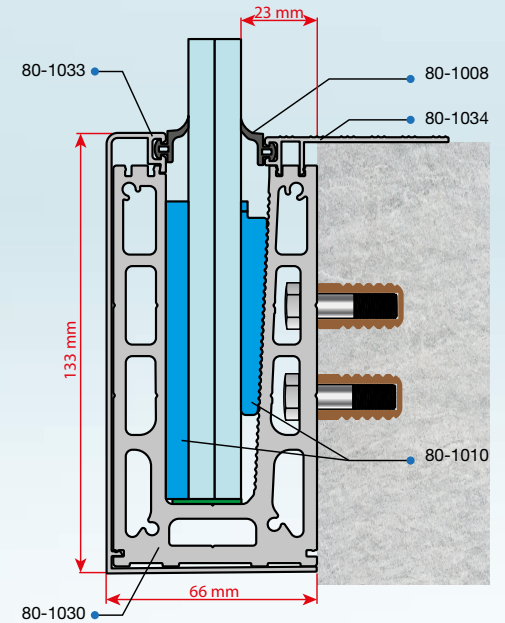
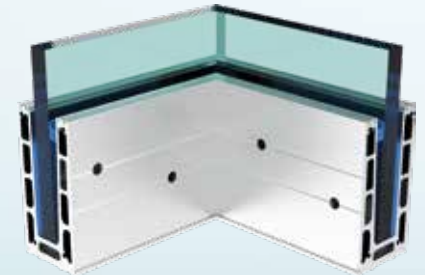
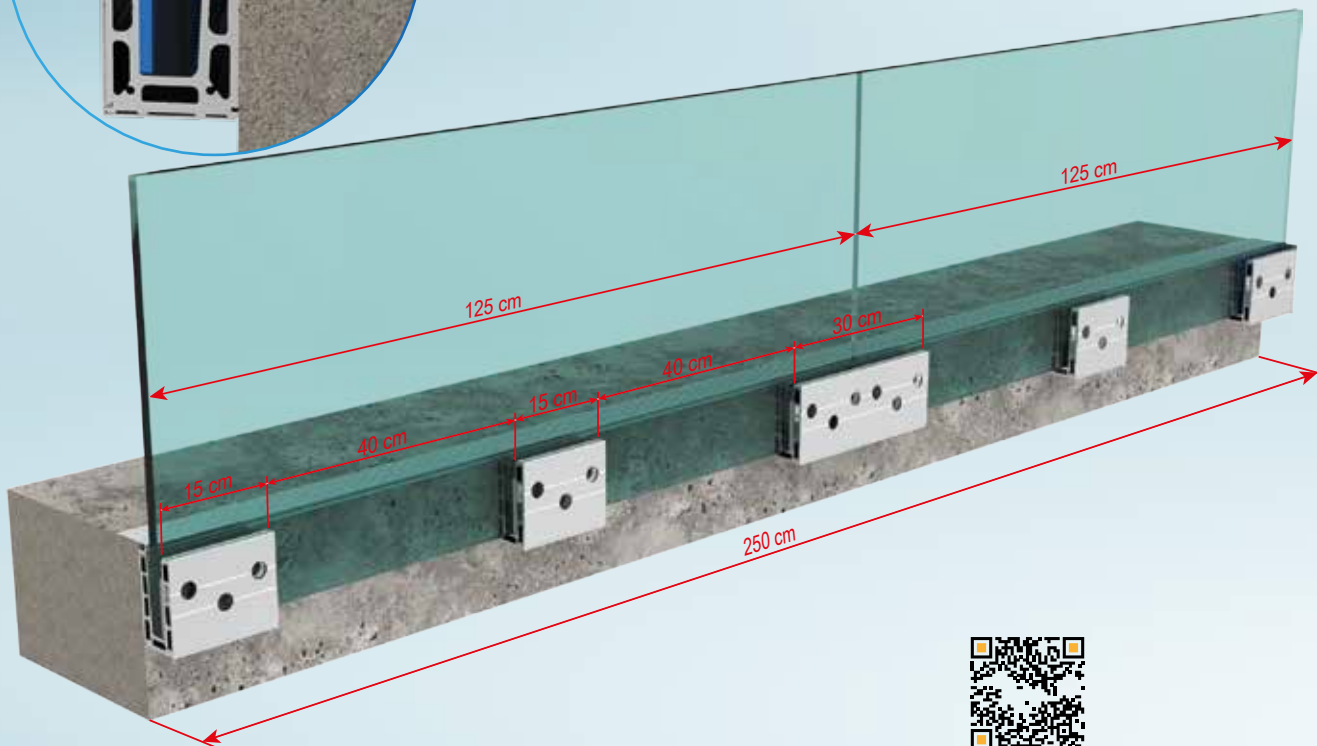
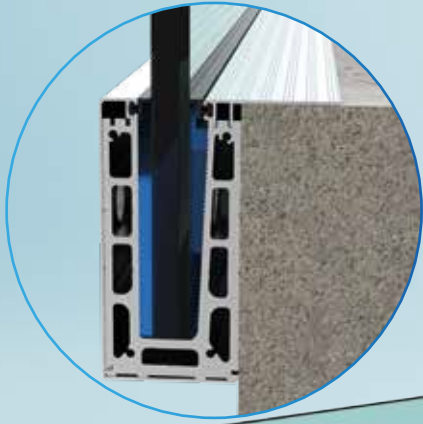

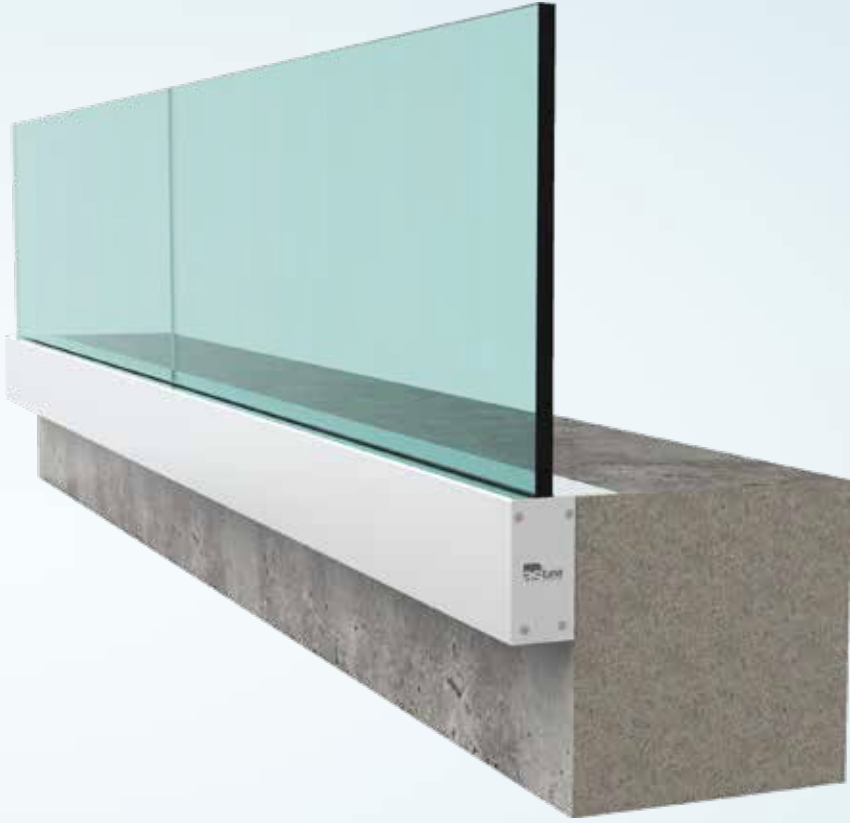

80-1030

CAM BAZA 15 cm  
GLASS BASE 15 cm



80-1031

CAM BAZA 30 cm  
GLASS BASE 30 cm

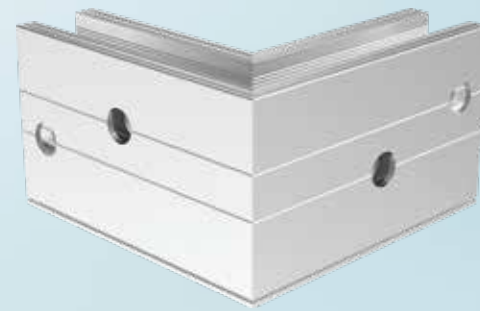

80-1032

CAM BAZA KÖŞE  
GLASS BASE CORNER



80-1035

BİTİŞ KAPAĞI  
SIDE COVER

Alternatifi cam seçenekleri ile geniş bir kullanım sağlamaktadır.

Cam Glass (mm)	D11 Serisi Cam Özellikleri D11 Series Glass Features			
Kalınlık <i>Thickness</i>	5+5	6+6	8+8	10+10
Uzunluk <i>Lenght</i>	2000	1750	1500	1250
Yükseklik <i>Height</i>	1100	1250	1350	1500

It provides a wide usage with alternative glass options.

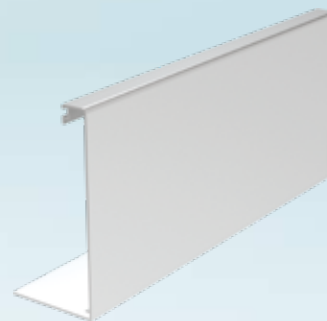

80-1033

KAPAK PROFİLİ  
PROFILE COVER

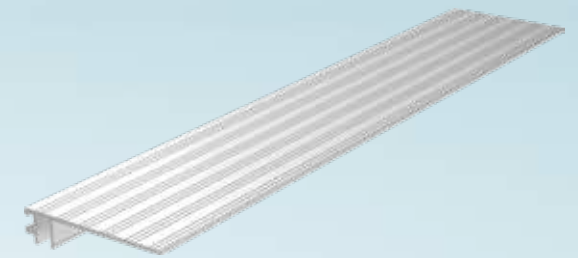

80-1034

KAPAK PROFİLİ  
PROFILE COVER



# B25 CAM BAZA SİSTEMİ

## B25 GLASS BASE SYSTEM

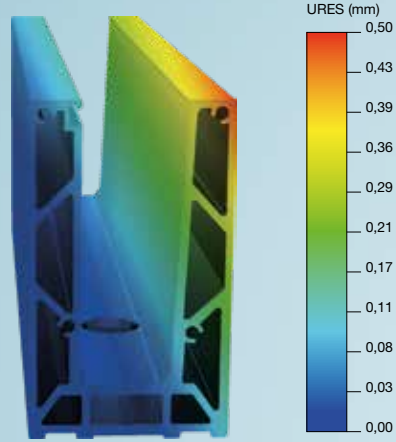

**TS498 , DIN 1055** standartlarına göre yapılan yüklemeler ve **AA-ASD-2000 Alüminyum design code** standartları ile yapılan hesaplama raporları ve testleri sonucu

Baza için çizgisel Gcam Hesabı

$$(62,3 \text{ kg / metre}) \times 6 \text{ metre} / 1,2 \text{ metre} = 311,5 \text{ kg/mt}$$

Yapılan statik analiz sonucuna göre max sehim şartı sağlanmıştır  
max sehim baza 0,60 mm  
max sehim cam 10,325 mm olarak hesaplanmıştır.

According to the Loads standards **TS498, DIN 1055** , and **AA-ASD-2000 Aluminum design code standards** The result of calculation reports and tests made with

Linear Gcam Calculation for the Base:

$$(62.3 \text{ kg / meter}) \times 6 \text{ meters} / 1.2 \text{ meters} = 311,5 \text{ kg/m}$$

According to the results of the static analysis, the maximum deflection condition was met.  
The max deflection of the base is **0.60 mm**  
The maximum deflection of the glass is calculated as **10,325 mm**.

Uygulanan Güç = 1.700 Newton  
1 Newton = 0,101 Kg



B25 sistemi, sağlam korkuluklar ve bölmeler oluşturmak için cam panellerini zemine sabitleyen yenilikçi bir alüminyum kanal sistemidir. Balkonlarda, galerilerde ve daha birçok alanda kullanılarak estetik bir görünüm sağlar. Uzman ekibimiz tarafından tasarlanan B25 sistemi, zamandan tasarruf etmeniz için en hızlı montaj yapılacak şekilde üretilmiştir.

The B25 system is an innovative aluminum channel system that anchors glass panels to the floor to create solid railings and partitions. It provides an aesthetic appearance by using it in balconies, galleries and many other areas. Designed by our expert team, the B25 system has been produced to be the fastest way in installation to save time.

- Cam üstü zengin profil seçeneği,
- Yüksek camlarda maximum güvenlik,
- Modüler tasarım ile hızlı montaj,
- Modern yapılar için alternatif tasarımlar
- Rich profile option on glass,
- Maximum safety in high windows,
- Fast assembly with modular design,
- Alternative designs to modern structures

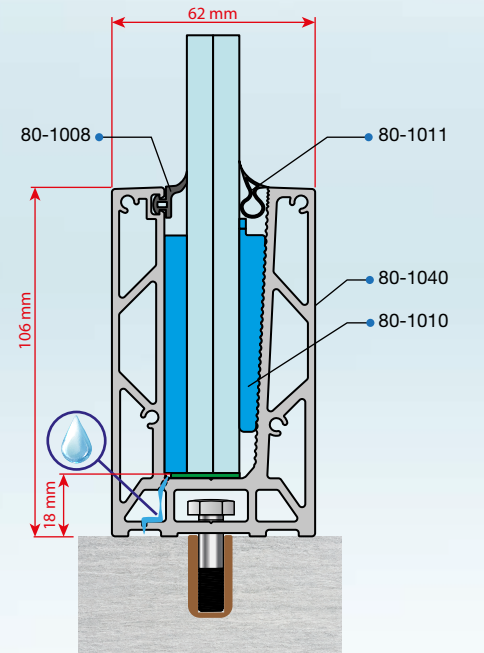
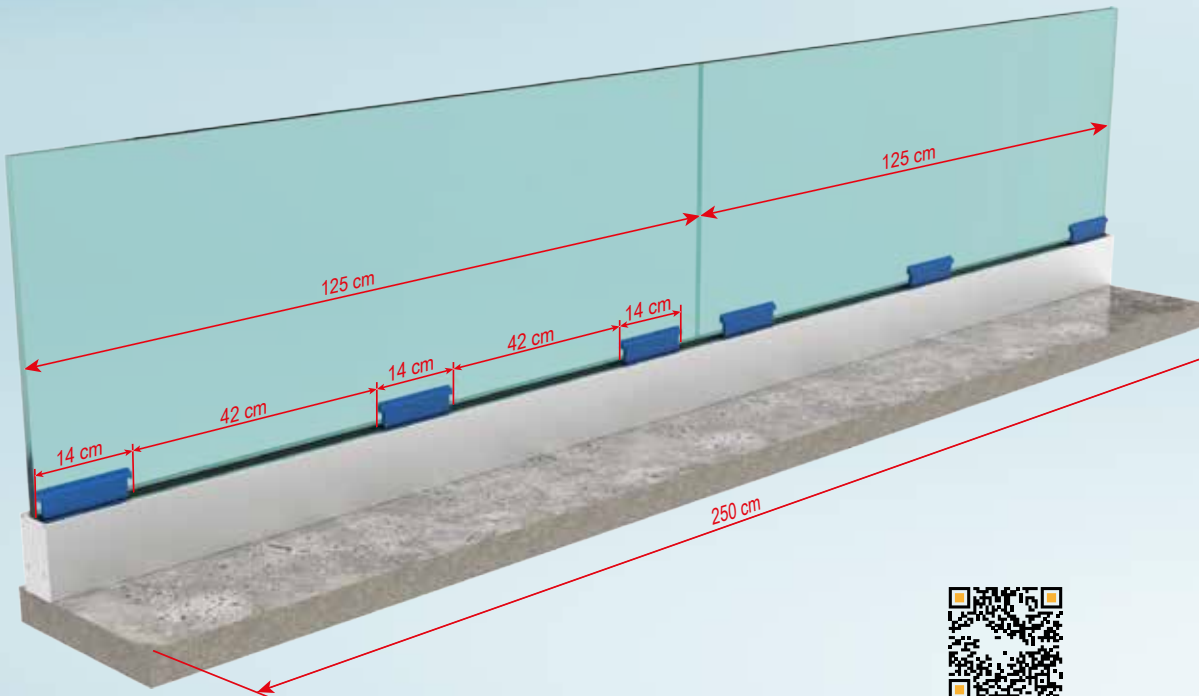



Alternatifli cam seçenekleri ile geniş bir kullanım sağlamaktadır.

Cam Glass (mm)	B25 Serisi Cam Özellikleri B25 Series Glass Features			
Kalınlık Thickness	5+5	6+6	8+8	10+10
Uzunluk Lenght	2000	1750	1500	1250
Yükseklik Height	1000	1150	1250	1500

It provides a wide usage with alternative glass options.

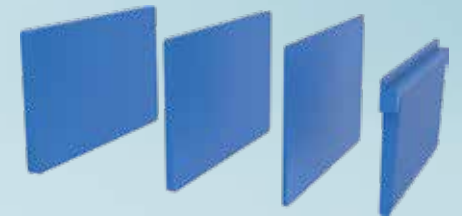

80-1010

SIKMA TAKOZ SETİ  
TIGHTENING WEDGE SET



80-1040

CAM BAZA  
GLASS BASE

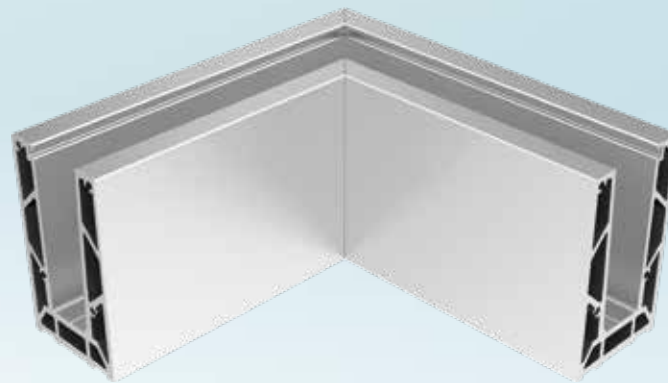

80-1041

CAM BAZA KÖŞE  
GLASS BASE CORNER



80-1042

BİTİŞ KAPAĞI  
SIDE COVER



# M84 CAM BAZA SİSTEMİ

## M84 GLASS BASE SYSTEM

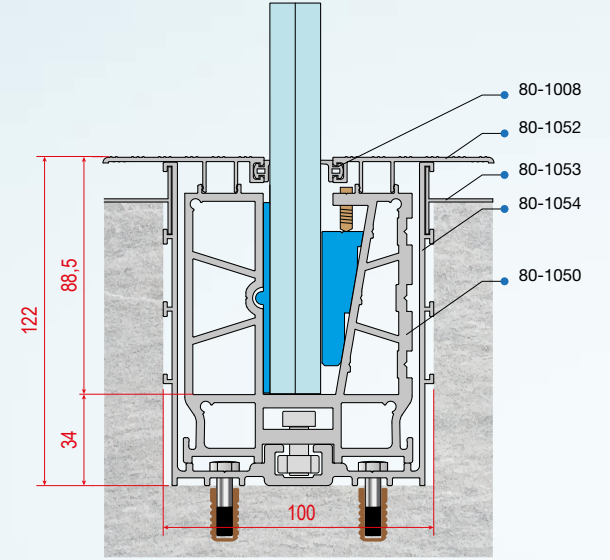

M84 SERİSİ ile şeffaflığı ve sağlamlığı ön planda tutarak yapılarınızı görünür kılıyoruz. Kesintisiz bir bağlantı oluşturmak istiyorsanız M84 SERİSİ kullanarak montaj kolaylığından faydalanabilirsiniz.

Balkonlarda, galerilerde ve daha birçok alanda şık bir görünüm sağlar. Hızlı ve kolay kurulum için tasarlanmıştır.

*With the M84 SERIES, we make your buildings visible by prioritizing transparency and durability. If you want to create an uninterrupted connection, you can benefit from the ease of installation by using the M84 SERIES.*

*It provides a stylish look on balconies and more areas. It is designed for quick and easy installation..*

Alternatifli cam seçenekleri ile geniş bir kullanım sağlamaktadır.  
*It provides a wide usage with alternative glass options.*

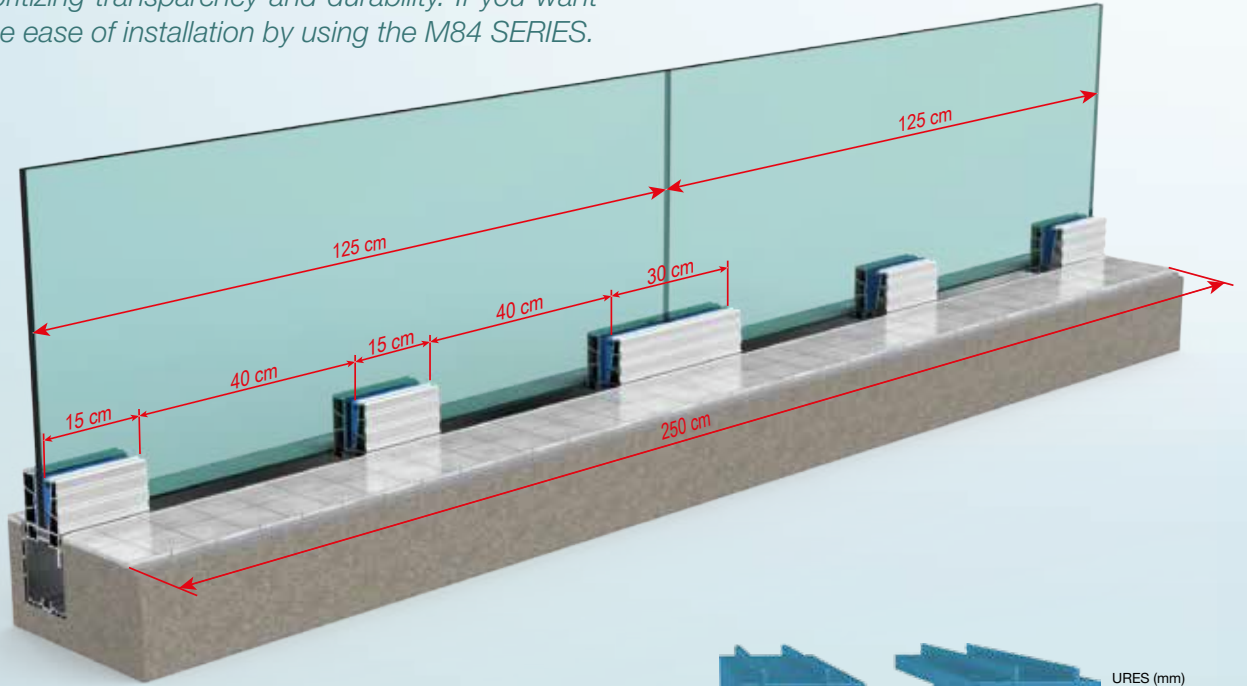

Cam Glass (mm)	M84 Serisi Cam Özellikleri M84 Series Glass Features			
Kalınlık Thickness	5+5	6+6	8+8	10+10
Uzunluk Length	2000	1750	1500	1250
Yükseklik Height	1100	1250	1350	1500



**TS498 , DIN 1055** standartlarına göre yapılan yüklemeler ve **AA-ASD-2000 Alüminyum design code standartları** ile yapılan hesaplama raporları ve testleri sonucu

Baza için çizgisel Gcam Hesabı

$$(55,7 \text{ kg / metre}) \times 6,7 \text{ metre} / 2,4 \text{ metre} = 155,49 \text{ kg/mt}$$

Yapılan statik analiz sonucuna göre max sehim şartı sağlanmıştır  
max sehim baza **0,00 mm**  
max sehim cam **11,2 mm** olarak hesaplanmıştır.

According to the Loads standards **TS498, DIN 1055** , and **AA-ASD-2000 Aluminum design code standards**  
The result of calculation reports and tests made with

Linear Gcam Calculation for the Base:

$$(55,7 \text{ kg / meter}) \times 6,7 \text{ meters} / 2,4 \text{ meters} = 155,49 \text{ kg/m}$$

According to the results of the static analysis, the maximum deflection condition was met.  
The max deflection of the base is **0,00 mm**  
The maximum deflection of the glass is calculated as **11,2 mm**.

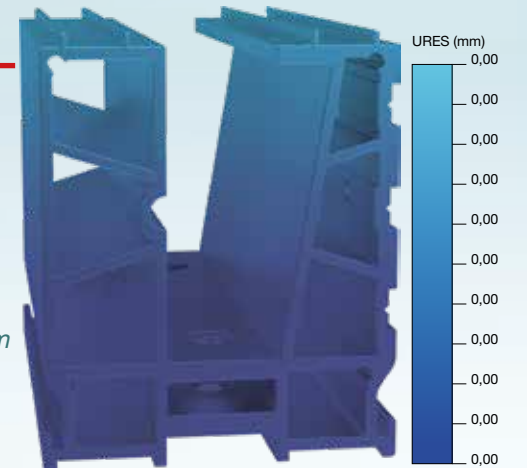



# M84 Serisi



80-1050

CAM BAZA 15 cm  
GLASS BASE 15 cm



80-1051

CAM BAZA 30 cm  
GLASS BASE 30 cm

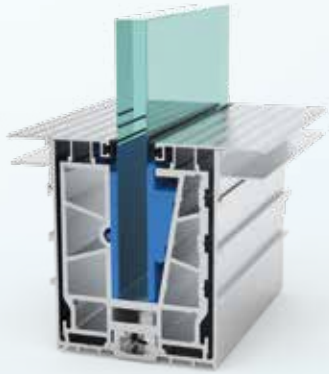

80-1052

KAPAK PROFİLİ  
PROFILE COVER

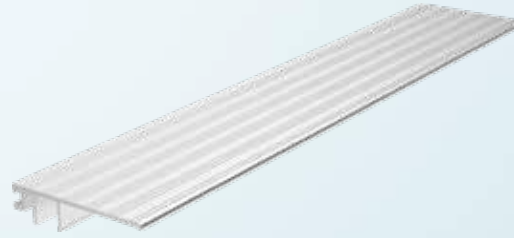

80-1053

ZEMİN KAPAK PROFİLİ  
GROUND PROFILE COVER



80-1054

ZEMİN PROFİLİ  
GROUND PROFILE

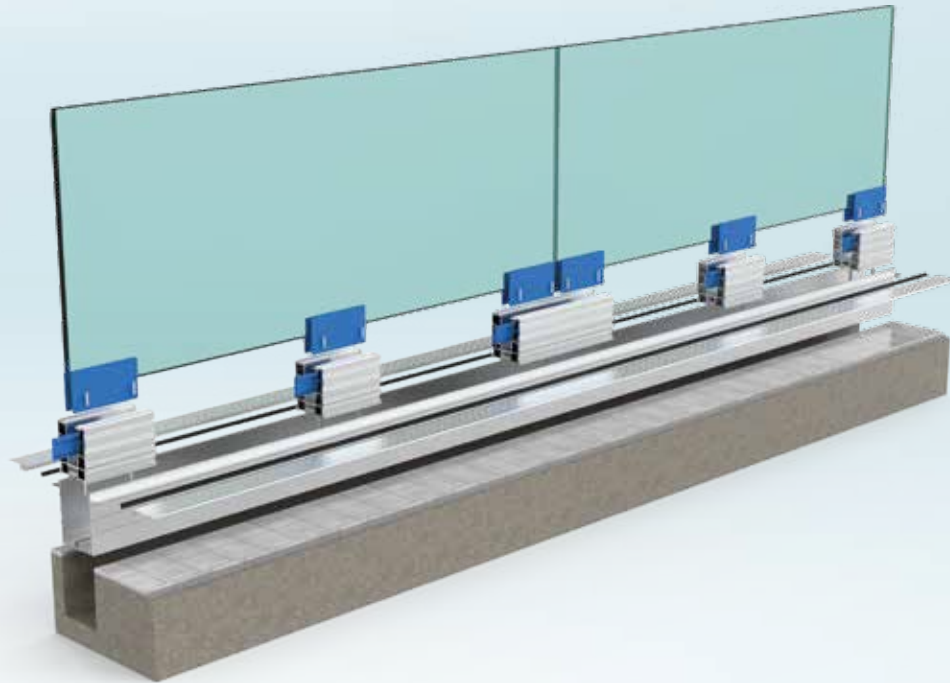

# CAM BAZA YARDIMCI ÜRÜNLER

## GLASS BASE COMMON PRODUCT

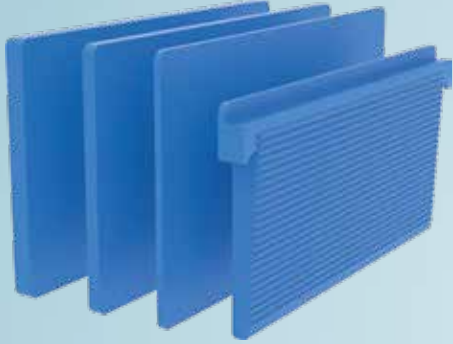

80-1010

SIKMA TAKOZ SETİ  
TIGHTENING WEDGE SET

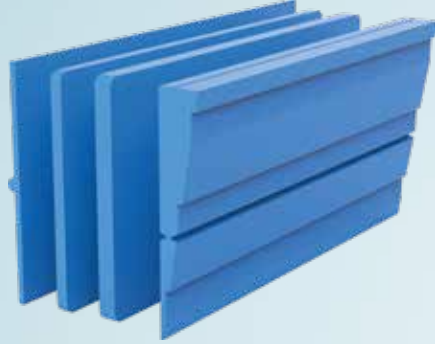

80-1009

SIKMA TAKOZ SETİ  
TIGHTENING WEDGE SET



80-1008

CAM FİTİLİ  
GLASS WICK



80-1011

CAM FİTİLİ  
GLASS WICK



17-3003

İMBUS VİDA  
IMPULS BOLT



17-3001

BULDEKS VİDA  
BULDEX SCREW



17-3004

ALTİGEN VİDA  
HEGZAGON SCREW



17-3005

DUBELLİ VİDA  
DOVEL SCREW



17-3006

YARIM DUBEL VİDA  
HALF DOVEL SCREW



17-2005

ÇELİK DUBEL  
STEEL DOVEL



17-3002

PLASTİK DUBEL  
PLASTIC DOVEL



17-1010

EPOKSİ YAPIŞTIRICI  
EPOXY ADHESIVE



17-1012

EPOKSİ TABANCASI  
EPOXY PISTOL



17-1014

MERMER YAPIŞTIRICISI  
MARBLE GLUE

# CAM BAZA ÜST PROFİLLER

## GLASS BASE TOP PROFILES

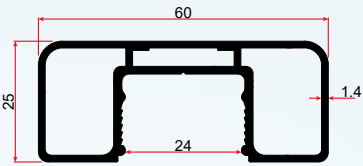

**PRF 0034**

0,834 KG/MT

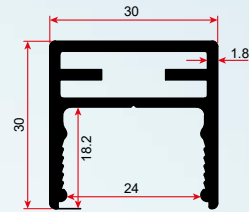

**PRF 0031**

0,658 KG/MT

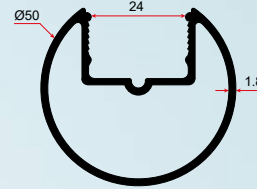

**PRF 0056**

RUBBER 16,5 MM

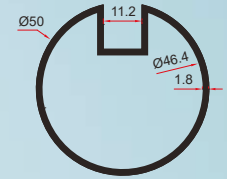

**PRF 0055**

RUBBER 12,5 MM

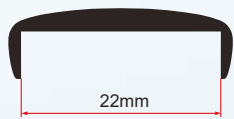

**PRF 0032**

0,190 KG/MT

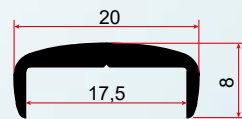

**PRF 0033**

0,140 KG/MT

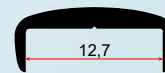

**PRF 0039**

0,113 KG/MT

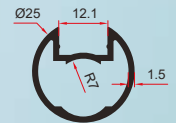

**PRF 0068**

0,135 KG/MT

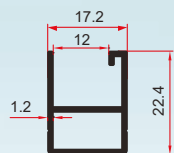

**PRF 0037**

0,254 KG/MT

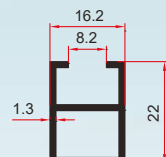

**PRF 0038**

0,267 KG/MT

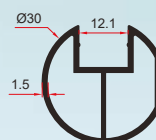

**PRF 0067**

0,155 KG/MT

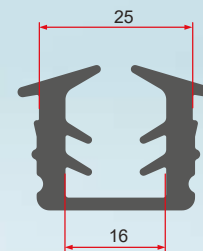

**PRF 0035**

RUBBER 12,5 MM

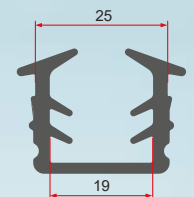

**PRF 0036**

RUBBER 16,5 MM



# LAMİNE CAM TEKNİK ÖZELLİKLER

## LAMINE GLASS TECHNICAL PRODUCT

5 + 5 mm Laminated Glass 100 cm Glass Height		
LENGHT mm (W)	GLASS WIDTH (T)	WEIGHT (KG)
900	5+1,52+5	23
1000	5+1,52+5	25
1100	5+1,52+5	27
1200	5+1,52+5	29

6 + 6 mm Laminated Glass 100 cm Glass Height		
LENGHT mm (W)	GLASS WIDTH (T)	WEIGHT (KG)
900	6+1,52+6	27
1000	6+1,52+6	30
1100	6+1,52+6	33
1200	6+1,52+6	36

8 + 8 mm Laminated Glass 100 cm Glass Height		
LENGHT mm (W)	GLASS WIDTH (T)	WEIGHT (KG)
900	8+1,52+8	36
1000	8+1,52+8	40
1100	8+1,52+8	44
1200	8+1,52+8	48

10 + 10 mm Laminated Glass 100 cm Glass Height		
LENGHT mm (W)	GLASS WIDTH (T)	WEIGHT (KG)
900	10+1,52+10	45
1000	10+1,52+10	50
1100	10+1,52+10	55
1200	10+1,52+10	60

### Lamine Cam;

Lamine cam renkli veya renksiz özel bağlayıcı polivinil butiral (PVB) tabakalar yardımıyla iki veya daha fazla cam plakanın ısı ve basınç altında birleştirilmesi ile üretilir. Kırılma halinde parçaları yerinde tutarak yaralanma risklerini azaltır. Bu özelliği nedeniyle lamine güvenlik camı olarak kabul edilir.

Lamine cam, bir taraftan diğer tarafa istenmeyen geçişleri önlemesi veya geciktirmesi açısından da doğru bir seçimdir. Laminasyon eğimli veya baş üstü camlamaların iç camları için standart ve tipik bir çözümdür. Lamine, yalıtım camı üniteleri, renksiz, harmandan renkli, kaplamalı ve ısıl işlemlerle camlarla birlikte oluşturulabilir. Lamine cam, düşük UV geçirgenliği ile eşyaların doğal renklerinin daha uzun süre korunması ve gürültü kontrolü açısından da yararlıdır.

Standart Lamine üretimi 0.38 mm kalınlıklı renksiz PVB ile yapılmaktadır. Ayrıca 0.76, 1.14 veya 1.52 mm kalınlıklı yapılabilir. Laminasyonda kullanılan camlar temperli ise 1.52 mm kalınlıklı PVB kullanılmaktadır.

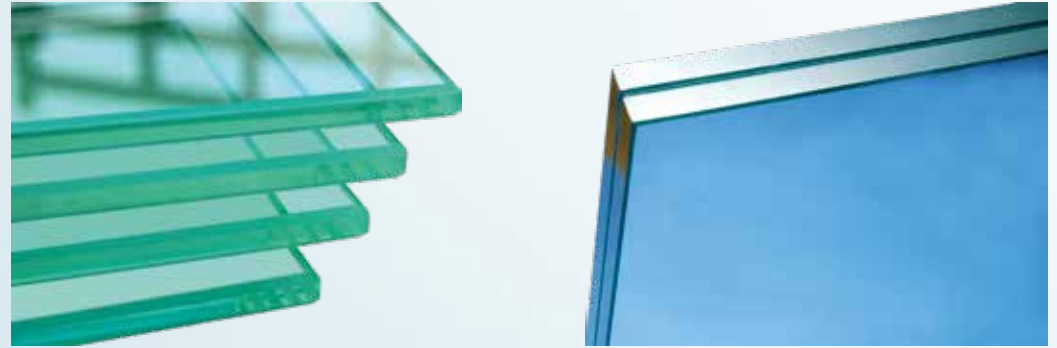

### Laminated Glass;

Laminated glass is produced by combining two or more glass plates under heat and pressure with the help of colored or colorless special binder polyvinyl butyral (PVB) layers. It keeps the parts in place in case of breakage, reducing the risk of injury. Due to this feature, it is considered as laminated safety glass.

Laminated glass is also the right choice in terms of preventing or delaying unwanted transitions from one side to the other. Inner glazing of laminated curved or overhead glazing. It is a standard and typical solution for Laminated, insulating glass units that can be formed with colorless, blended tinted, coated and heat-treated glass. Laminated glass is also useful in terms of protecting the natural colors of the goods for a longer time and noise control with its low UV transmittance.

Standard Lamine production is made with 0.38 mm thick colorless PVB. In addition, it can be made with a thickness of 0.76, 1.14 or 1.52 mm. If the glass/glasses used in lamination are tempered, 1.52 mm thick PVB is used.

# DK10 CAM TAŞIYICI SİSTEMİ

## DK10 GLASS CARRIER SYSTEM

# DK10

Serisi



80-4050

CAM TAŞIYICI  
GLASS CARRIER

Alternatifi cam seçenekleri ile geniş bir kullanım sağlamaktadır.  
*It provides a wide usage with alternative glass options.*

Cam Glass (mm)	DK10 Serisi Cam Özellikleri DK10 Series Glass Features	
Kalınlık <i>Thickness</i>	8+8	10+10
Uzunluk <i>Length</i>	1500	1250
Yükseklik <i>Height</i>	1350	1500

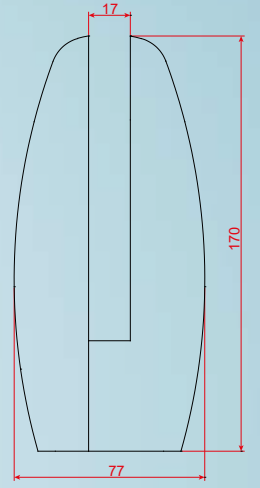

- Kolay montaj ile sağlamlığı estetiğe dönüştürür.
- Dar alanlar ve montaj zorluğu olan yerlerde avantaj sağlar.

DK10 cam korkuluk sistemi, güç veya dayanıklılıktan ödün vermeden korkuluk boylarına istenilen ölçülerde ayarlanarak görünürlüğü en üst düzeye çıkarır.

- *It transforms durability into aesthetics with easy assembly.*
- *It provides an advantage in narrow spaces and places where assembly is difficult.*

*The DK10 glass balustrade system is preferred over its wearability in looks that are preferred over its heights that are not designed to fear strength or durability.*

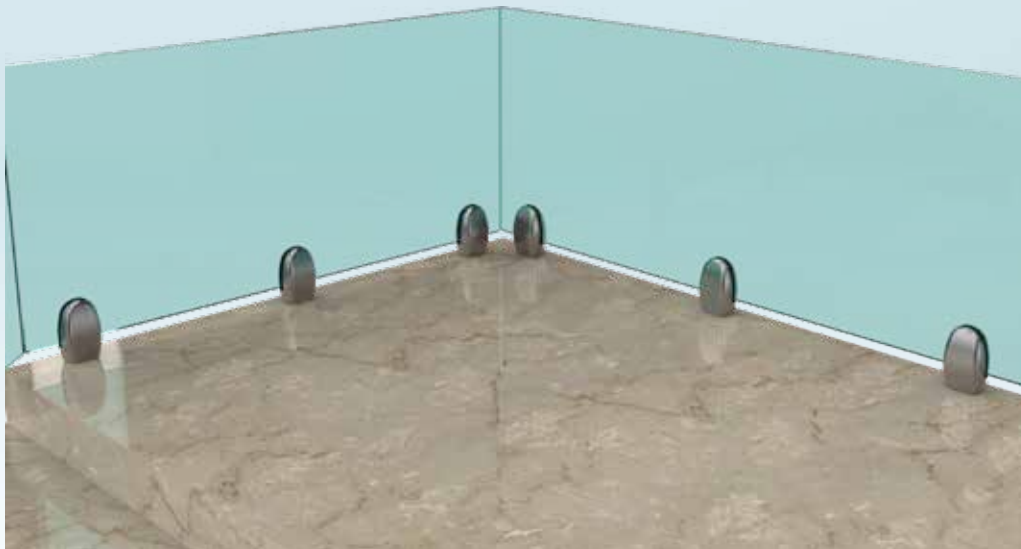

# AK61 CAM ADAPTÖR SİSTEMİ

## AK61 GLASS ADAPTER SYSTEM

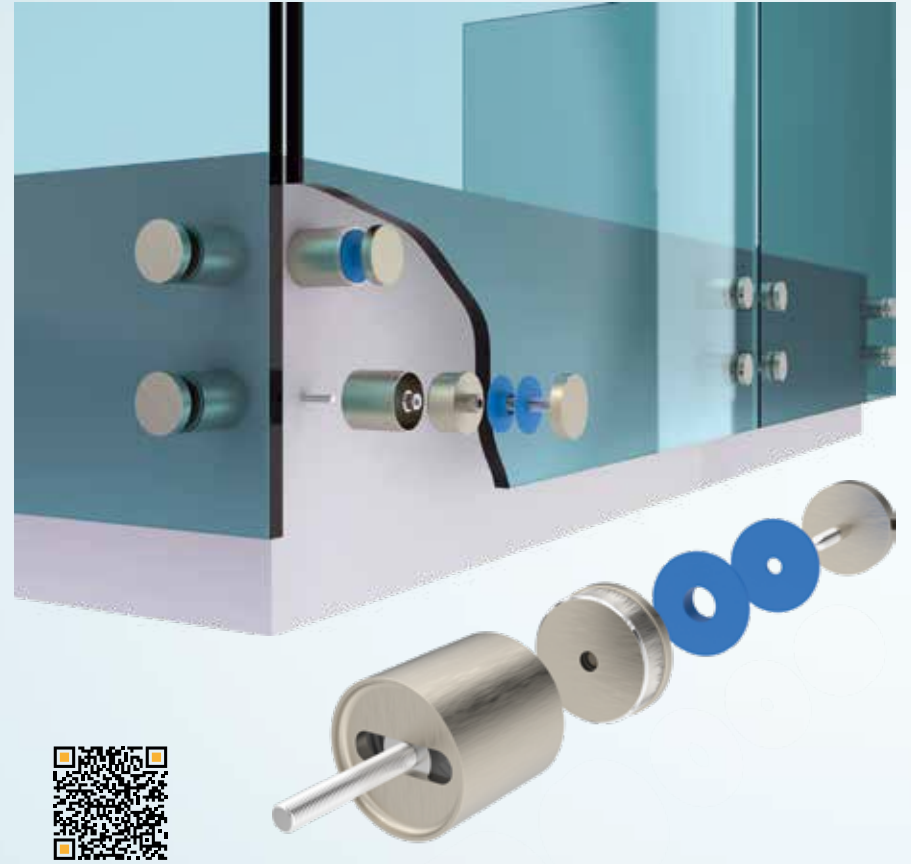

AK61 Cam Adaptörleri tamamen çerçevesiz dikey direkleri ortadan kaldıran sistemlerdir. Duvar ile bütünleşen bağlantısıyla bir bütünlük ve kesintisiz görünüm sağlar. İç ve dış mekanlarda camın zarafetini ön plana çıkartarak her duvara uyum sağlar.

- Zengin çeşitliliğiyle çelik konstrüksiyon, beton, ahşap zeminler ve diğer duvar türlerine uygulanabilir
- Kendinden ayarlanabilir özelliğiyle camda ve zeminde oluşabilecek hataları tolere edebilir.
- Kolay montaj , sağlamlık ve estetik ile yapılarınıza değer katar.

*AK61 Glass Adapters are completely frameless systems that eliminate vertical pillars. It provides integrity and an uninterrupted appearance with its integration with the wall. It brings the elegance of glass to the forefront in interior and exterior spaces and adapts to any wall.*

- *With its wide variety, it can be applied to steel construction, concrete, wooden floors, and other wall types.*
- *With its self-adjustable feature, it can tolerate errors that may occur on the glass and the floor.*
- *It adds value to your buildings with easy assembly, durability, and aesthetics.*





# AK61 Serisi

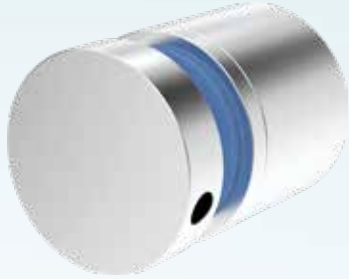

10-3040

Ø40 ADAPTÖR 5 cm  
Ø40 ADAPTER 5 cm

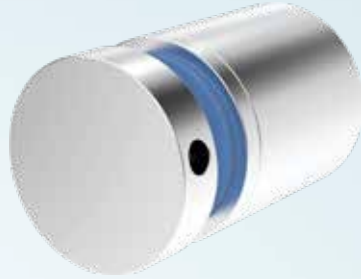

10-3041

Ø40 ADAPTÖR 6 cm  
Ø40 ADAPTER 6 cm

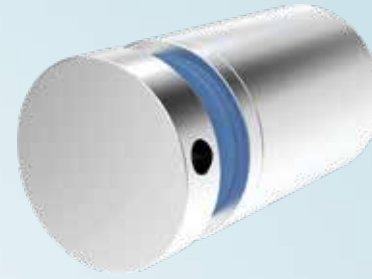

10-3042

Ø40 ADAPTÖR 7 cm  
Ø40 ADAPTER 7 cm



10-3002

Ø42 ADAPTÖR  
Ø42 ADAPTER



10-3043

Ø40 ADAPTÖR VİDALI 5 cm  
Ø40 ADAPTER SCREW 5 cm



10-3044

Ø40 ADAPTÖR VİDALI 6 cm  
Ø40 ADAPTER SCREW 6 cm



10-3045

Ø40 ADAPTÖR VİDALI 7 cm  
Ø40 ADAPTER SCREW 7 cm



10-3001

Ø30 ADAPTÖR  
Ø30 ADAPTER



10-3003

Ø35 ADAPTÖR  
Ø35 ADAPTER

Alternatifli cam seçenekleri ile geniş bir kullanım sağlamaktadır.  
*It provides a wide usage with alternative glass options.*

Cam Glass (mm)	AK61 Serisi Cam Özellikleri AK61 Series Glass Features			
Kalınlık Thickness	5+5	6+6	8+8	10+10
Uzunluk Length	2000	1750	1500	1250
Yükseklik Height	1100	1250	1350	1500



# AK61 CAM ADAPTÖR SİSTEMİ

## AK61 GLASS ADAPTER SYSTEM



10-3006

40x40 ÇİFTLİ ADAPTÖR  
40x40 DOUBLE ADAPTER



10-3005

Ø50 ÇİFTLİ ADAPTÖR  
Ø50 DOUBLE ADAPTER



10-3007

Ø50 ÇİFTLİ ADAPTÖR  
Ø50 DOUBLE ADAPTER





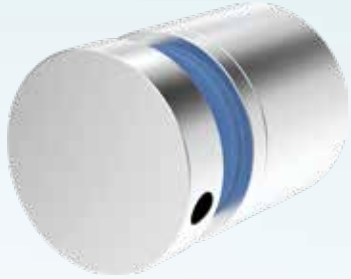

10-3050

Ø50 ADAPTÖR 5 cm  
Ø50 ADAPTER 5 cm

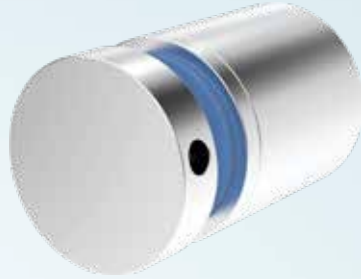

10-3051

Ø50 ADAPTÖR 6 cm  
Ø50 ADAPTER 6 cm

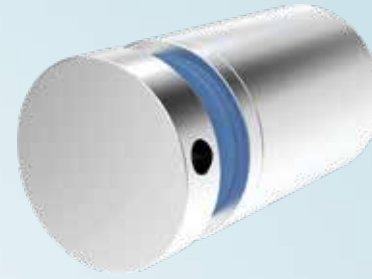

10-3052

Ø50 ADAPTÖR 7 cm  
Ø50 ADAPTER 7 cm



10-3004

40x40 ADAPTÖR  
40x40 ADAPTER



10-3053

Ø50 ADAPTÖR VİDALI 5 cm  
Ø50 ADAPTER SCREW 5 cm



10-3054

Ø50 ADAPTÖR VİDALI 6 cm  
Ø50 ADAPTER SCREW 6 cm



10-3055

Ø50 ADAPTÖR VİDALI 7 cm  
Ø50 ADAPTER SCREW 7 cm

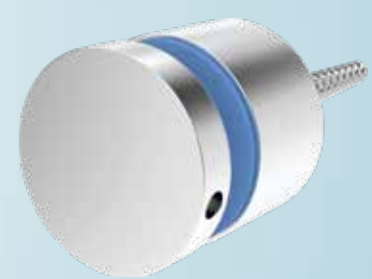

10-3056

Ø50 ADAPTÖR (3-4-5 cm)  
Ø50 ADAPTER (3-4-5 cm)

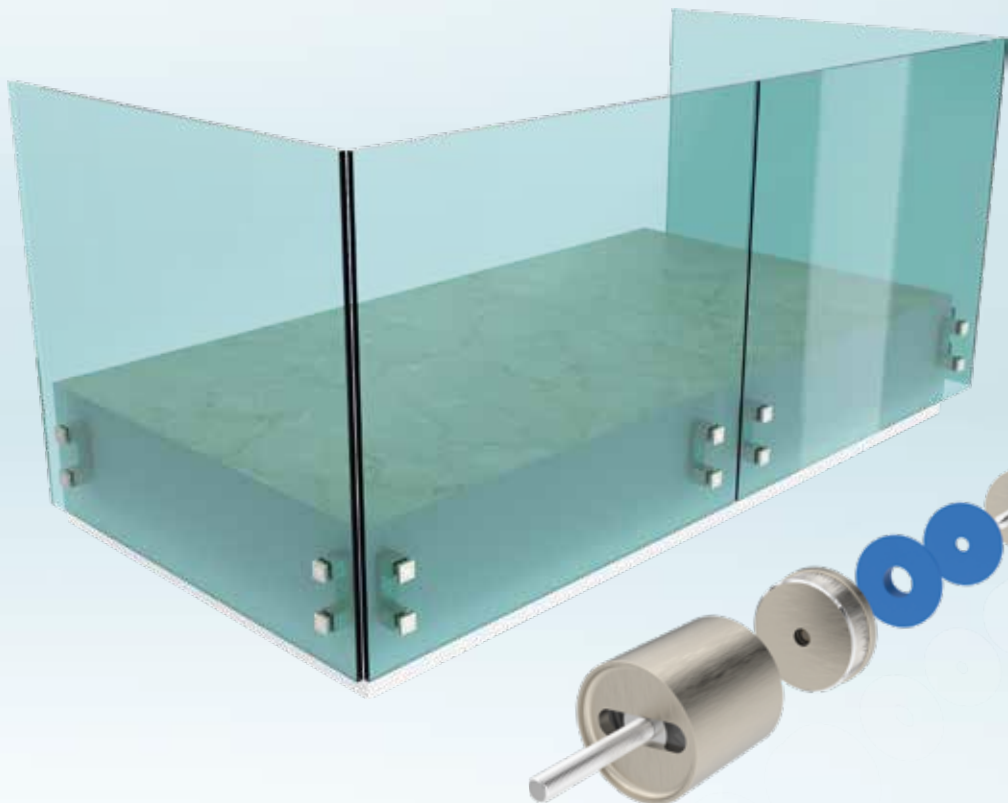

AK61 Cam Adaptörleri tamamen çerçevesiz dikey direkleri ortadan kaldıran sistemlerdir. Duvar ile bütünleşen bağlantısıyla bir bütünlük ve kesintisiz görünüm sağlar. İç ve dış mekanlarda camın zarafetini ön plana çıkartarak her duvara uyum sağlar.

- Zengin çeşitliliğiyle çelik konstrüksiyon, beton, ahşap zeminler ve diğer duvar türlerine uygulanabilir.
- Kendinden ayarlanabilir özelliğiyle camda ve zeminde oluşabilecek hataları tolere edebilir.
- Kolay montaj, sağlamlık ve estetik ile yapılarınıza değer katar.

*AK61 Glass Adapters are completely frameless systems that eliminate vertical pillars. It provides integrity and an uninterrupted appearance with its integration with the wall. It brings the elegance of glass to the forefront in interior and exterior spaces and adapts to any wall.*

- With its wide variety, it can be applied to steel construction, concrete, wooden floors, and other wall types.
- With its self-adjustable feature, it can tolerate errors that may occur on the glass and the floor.
- It adds value to your buildings with easy assembly, durability, and aesthetics.

# LM20 CAM TAŞIYICI SİSTEMİ

## LM20 GLASS CARRIER SYSTEM

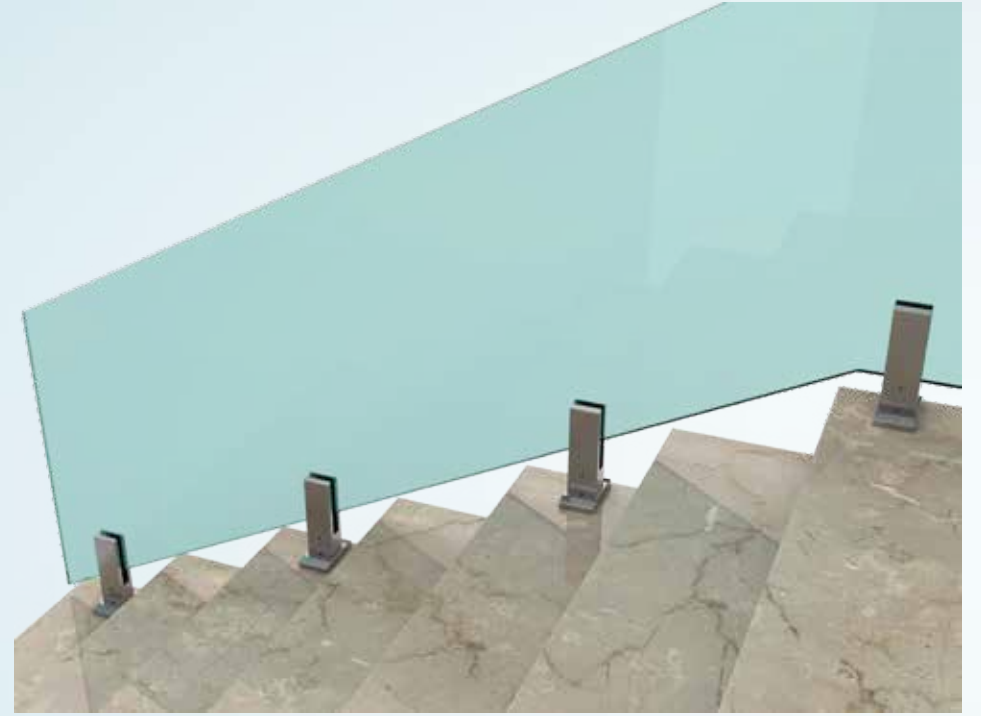

- Modüler tasarımları sayesinde, benzersiz korkuluklar oluşturarak mekânlarınızı görünür kılar ve binalarınızda bütünleyici bir görünüş oluşturur.
- Kolay montaj ile sağlamlığı estetiğe dönüştürür.
- Dar alanlar ve montaj zorluğu olan yerlerde avantaj sağlar.



- Thanks to its modular designs, it creates unique balustrades, making your spaces visible and creating an integral appearance in your buildings.
- It transforms durability into aesthetics with easy assembly.
- It provides an advantage in narrow spaces and places where assembly is difficult.





# LM20 Serisi

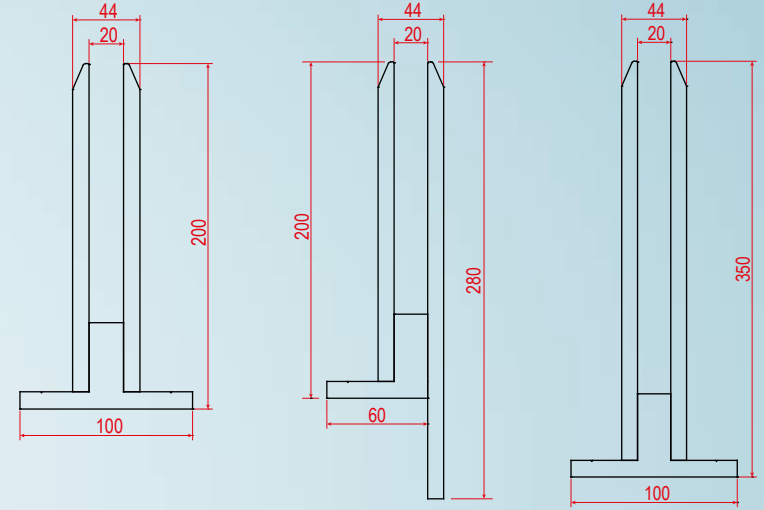

80-4004

10 MM - 12 MM CAM TAŞIYICI  
10 MM - 12 MM GLASS CARRIER



80-4001

16 MM CAM TAŞIYICI  
16 MM GLASS CARRIER



80-4002

CAM TAŞIYICI  
GLASS CARRIER



80-4003

CAM TAŞIYICI  
GLASS CARRIER



80-4110

CAM TAŞIYICI  
GLASS CARRIER



80-4101

CAM TAŞIYICI  
GLASS CARRIER



80-4102

CAM TAŞIYICI  
GLASS CARRIER



80-4103

CAM TAŞIYICI  
GLASS CARRIER

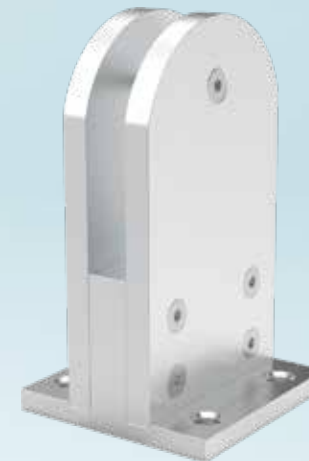

80-4011

CAM TAŞIYICI  
GLASS CARRIER



80-4010

CAM TAŞIYICI  
GLASS CARRIER

# CF33 CAM TAŞIYICI SİSTEMİ

## CF33 GLASS CARRIER SYSTEM

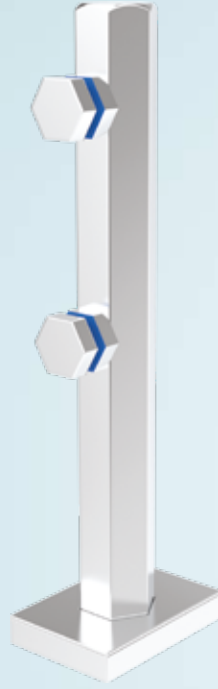

80-6007

ALTİGEN CAM TAŞIYICI  
HEGZAGON GLASS CARRIER



80-6009

20x50 CAM TAŞIYICI OVAL PUL  
20x50 GLASS CARRIER ROUND W.



80-6006

20x50 CAM TAŞIYICI KARE PUL  
20x50 GLASS CARRIER SQUARE W.

CF33 SERİSİ düz olmayan yüzeylerde kullanımı kolaylaştıran seviyelendirmeye izin veren bir sistemdir.

CF33 cam korkuluk sistemi, güç veya dayanıklılıktan ödün vermeden korkuluk boylarına istenilen ölçülerde ayarlanarak görünürlüğü en üst düzeye çıkarır.



*It is the CF33 SERIES that allow leveling a system that improves use on the uneven*

*The CF33 glass balustrade system is preferred over its wearability in looks that are preferred over its heights that are not designed to fear strength or durability.*



Alternatifli cam seçenekleri ile geniş bir kullanım sağlamaktadır.

Cam Glass (mm)	CF33 Serisi Cam Özellikleri					CF33 Series Glass Features
Kalınlık Thickness	8	5+5	6+6	8+8	10+10	
Uzunluk Lenght	1250	2000	1750	1500	1250	
Yükseklik Height	1000	1000	1150	1250	1500	

It provides a wide usage with alternative glass options.



80-6002

Ø30 CAM TAŞIYICI  
Ø30 GLASS CARRIER



80-6008

Ø40 YUVARLAK CAM TAŞIYICI  
Ø40 ROUND GLASS CARRIER

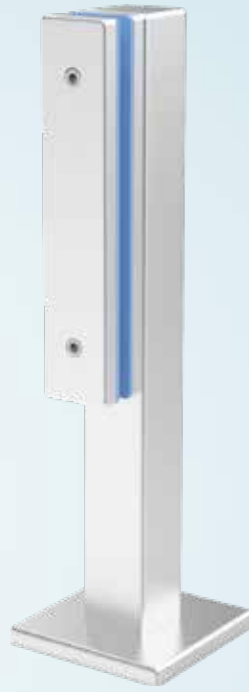

80-6003

40x40 LAMA CAM TAŞIYICI  
40x40 LAME GLASS CARRIER



80-6005

40x40 KARE PUL CAM TAŞIYICI  
40x40 SQUARE W. GLASS CARRIER



80-6010

40x40 OVAL PUL CAM TAŞIYICI  
40x40 ROUND W. GLASS CARRIER



80-6004

EKO CAM TAŞIYICI  
ECO GLASS CARRIER

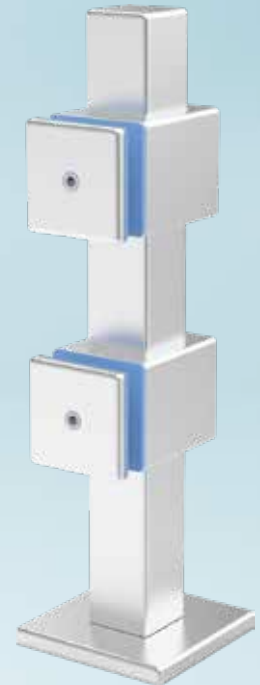

80-6001

40x40 CAM TAŞIYICI AYARLI  
40x40 GLASS CARRIER ADJUSTABLE



# K21 CAM TAŞIYICI SİSTEMİ

## K21 GLASS CARRIER SYSTEM



80-3005

CAM TAŞIYICI 12,5 cm  
GLASS CARRIER 12,5 cm



80-3002

CAM TAŞIYICI 10 cm  
GLASS CARRIER 10 cm



80-3003

CAM TAŞIYICI 7,5 cm  
GLASS CARRIER 7,5 cm



80-3004

CAM TAŞIYICI 5 cm  
GLASS CARRIER 5 cm





80-2001

CAM TAŞIYICI 12,5 cm  
GLASS CARRIER 12,5 cm



80-2002

CAM TAŞIYICI 10 cm  
GLASS CARRIER 10 cm



80-2003

CAM TAŞIYICI 7,5 cm  
GLASS CARRIER 7,5 cm



80-2004

CAM TAŞIYICI 5 cm  
GLASS CARRIER 5 cm

Modern hatları ve son derece güçlü tasarımları ile K21 CAM AYAK SİSTEMİ tarzınızı yükseltir ve güzel, dayanıklı bir korkuluk seçeneği sunar.

Kesiminden cnc işlemesine polisajından eloksal kaplamasına kadar özenle hazırlanan cam ayaklar ergonomik tasarımları ile yapılaraya değer katar

Merdivenler, balkonlar, havuz bölmesi, bahçe bölmesi gibi birçok yerde güvenlik ve estetik amaçlı kullanılan K21 cam ayak sistemleri ile tarzınızı ve güvenliğinizi maksimum seviyeye çıkarır.

*With its modern lines and extremely strong designs, the K21 GLASS FOOT SYSTEM elevates your style and offers a beautiful, durable railing option.*

*Glass feet, which are carefully prepared from cutting to cnc machining, from polishing to anodized coating, add value to buildings with their ergonomic designs.*

*K21 glass foot systems, which are used for security and aesthetic purposes in many places such as stairs, balconies, pool partitions, garden partitions, maximize your style and safety.*



80-5001

OVAL CAM TAŞIYICI  
ROUND GLASS CARRIER



80-2005

ELİPS CAM TAŞIYICI  
ELLIPTIC GLASS CARRIER

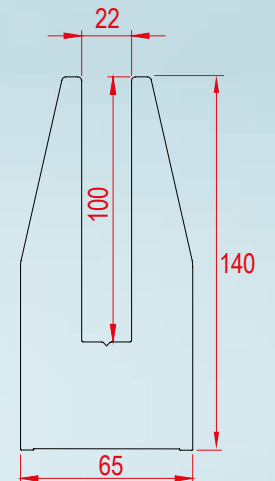



# K21 CAM TAŞIYICI SİSTEMİ

## K21 GLASS CARRIER SYSTEM



80-7002

CAM TAŞIYICI (5-7,5 cm)  
GLASS CARRIER (5-7,5 cm)



80-7008

CAM TAŞIYICI  
GLASS CARRIER



80-7005

CAM TAŞIYICI  
GLASS CARRIER



80-7006

CAM TAŞIYICI  
GLASS CARRIER



80-7007

CAM TAŞIYICI  
GLASS CARRIER

K21 SERİSİ düz olmayan yüzeylerde kullanımı kolaylaştıran seviyelendirmeye izin veren bir sistemdir. K21 cam korkuluk sistemi, güç veya dayanıklılıktan ödün vermeden korkuluk boylarına istenilen ölçülerde ayarlanarak görünürlüğü en üst düzeye çıkarır.

*It is the K21 SERIES that allow leveling a system that improves use on the uneven. The K21 glass balustrade system is preferred over its wearability in looks that are preferred over its heights that are not designed to fear strength or durability.*



Alternatifli cam seçenekleri ile geniş bir kullanım sağlamaktadır.  
It provides a wide usage with alternative glass options.

Cam Glass (mm)	K21 Serisi Cam Özellikleri K21 Series Glass Features					
	6	8	5+5	6+6	8+8	10+10
<b>Kalınlık Thickness</b>	6	8	5+5	6+6	8+8	10+10
<b>Uzunluk Length</b>	1000	1250	2000	1750	1500	1250
<b>Yükseklik Height</b>	900	1000	1000	1150	1250	1500



80-7003

CAM TAŞIYICI  
GLASS CARRIER



80-7004

CAM TAŞIYICI  
GLASS CARRIER



80-5003

CAM TAŞIYICI  
GLASS CARRIER



80-5002

CAM TAŞIYICI  
GLASS CARRIER



80-5005

CAM TAŞIYICI  
GLASS CARRIER



Cam Glass (mm)	K21 Küçük Serisi Cam Özellikleri <i>K21 Small Series Glass Features</i>			
Kalınlık <i>Thickness</i>	6	8	5+5	6+6
Uzunluk <i>Lenght</i>	1000	1250	2000	1750
Yükseklik <i>Height</i>	900	1000	1000	1150

Alternatifli cam seçenekleri ile geniş bir kullanım sağlamaktadır.  
*It provides a wide usage with alternative glass options.*



80-5010

KÜÇÜK CAM TAŞIYICI  
SMALL GLASS CARRIER



80-5011

KÜÇÜK CAM TAŞIYICI  
SMALL GLASS CARRIER



80-5012

KÜÇÜK CAM TAŞIYICI  
SMALL GLASS CARRIER



80-5013

KÜÇÜK CAM TAŞIYICI  
SMALL GLASS CARRIER

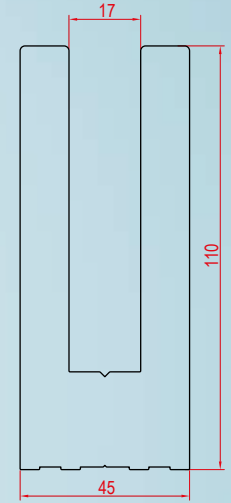

# S29 CAM TUTAMAK SİSTEMİ

## S29 GLASS HANDLE SYSTEM

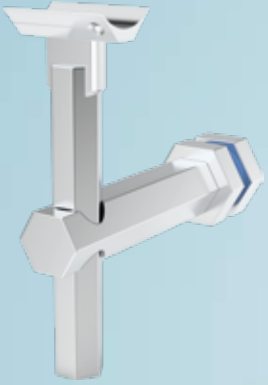

10-5012

ALTİGEN CAM TUTAMAĐI  
HEXAGON GLASS HANDLE

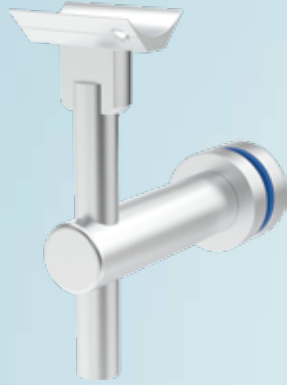

10-5013

KANADA CAM TUTAMAĐI  
CANADA GLASS HANDLE



10-5006

KARE CAM TUTAMAĐI  
SQUARE GLASS HANDLE



10-5005

LAMA CAM TUTAMAĐI  
LAME GLASS HANDLE



10-5007

OVAL CAM TUTAMAĐI  
ROUND GLASS HANDLE

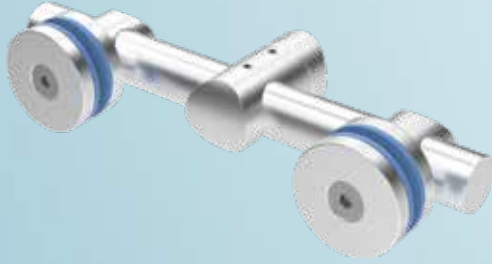

10-5010

ÇİFTLİ CAM TUTAMAĐI  
DOUBLE GLASS HANDLE



10-5011

TEKLİ CAM TUTAMAĐI  
SINGLE GLASS HANDLE



10-5004

EKO CAM TUTAMAĐI  
ECO GLASS HANDLE



15-5010

DUVAR KOLÇAĐI  
WALL SIDE L CONNECTOR



10-5020

CAM TUTAMAK SETİ  
GLASS HANDLE SET





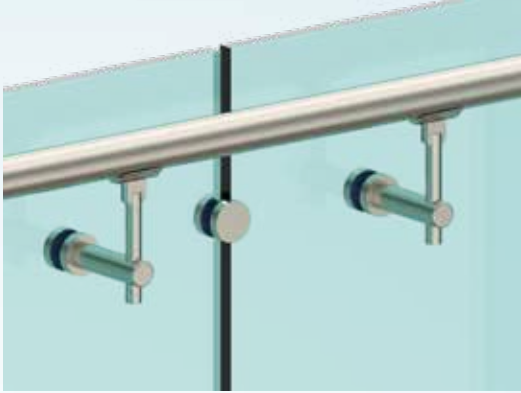

Cam Glass (mm)	S29 Serisi Cam Özellikleri S29 Series Glass Features					
Kalınlık Thickness	6	8	5+5	6+6	8+8	10+10



S29 cam kolçak ve destek sistemi;

Cam baza sistemlerinde dayanak ve tutamak yapımı için kullanılan S29 sistemi cam ile alüminyum arasında mükemmel geçişi sağlar. Oluşturulan el tutamaklarında güvenliği ve estetiği ön plana çıkarır. Tüm cam kalınlıklarına uyumludur

*S29 glass armrest and aligner system;*

*The S29 system, which is used for the construction of abutments and handles in glass plinth systems, provides a perfect transition between glass and aluminum. Highlights safety and aesthetics in the handgrips created. Compatible with all glass thicknesses.*



10-5008

OVAL CAM DESTEKLEYİCİ  
ROUND SUPPORT ALIGNER



10-5009

KARE CAM DESTEKLEYİCİ  
SQUARE SUPPORT ALIGNER

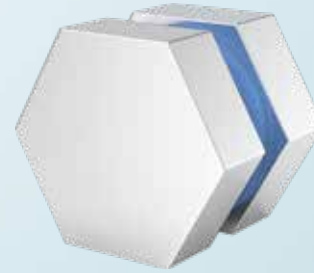

10-5014

ALTIGEN CAM DESTEKLEYİCİ  
HEXAGON SUPPORT ALIGNER









# LAMA DİKME SİSTEMİ

## LAMA STRUTS SYSTEM

LM80  
Serisi



70-1001

LAMA DİKME  
LAMA STRUTS



70-1002

LAMA DİKME  
LAMA STRUTS



70-1003

LAMA DİKME  
LAMA STRUTS



70-1004

LAMA DİKME  
LAMA STRUTS



70-1007

LAMA DİKME  
LAMA STRUTS



70-1006

LAMA DİKME  
LAMA STRUTS



70-1005

LAMA DİKME  
LAMA STRUTS



70-1008

LAMA DİKME  
LAMA STRUTS



70-1009

LAMA DİKME  
LAMA STRUTS

# 40 x 25 KARE AKSESUARLARI

metal & alüminyum

## SQUARE 40 x 25 ACCESSORIES



40-2501

40x25 ÜST BAĞLANTI TK  
40X25 CONNECTOR SET  
WITH JOINT

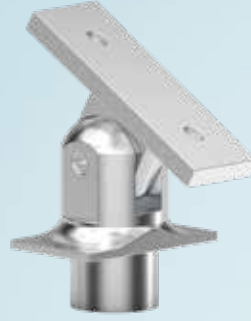

40-2502

40x25 LAMALI ÜST BAĞLANTI TK  
40X25 CONNECTOR SET WITH  
JOINT WITH LAME

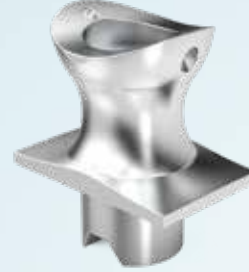

41-2501

40x25 SABİT MAFSAL  
40X25 CONNECTOR FITTING



41-2502

40x25 LAMALI SABİT MAFSAL  
40X25 CONNECTOR FITTING  
WITH LAME

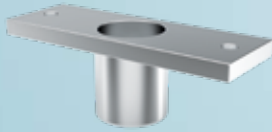

41-4006

LAMALI GİZLİ SABİT MAFSAL  
HIDDEN FIXED CONNECTOR  
FITTING



42-2501

40x25 DİKME FLANŞ  
40X25 GROUND FLANGE

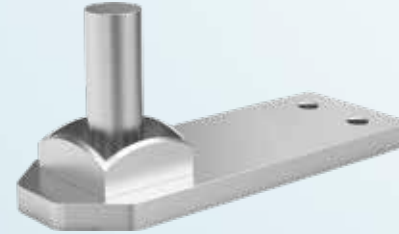

45-4003

40x40 UZATMA APARATI  
40X40 EXTENSION  
APPARATUS



45-4002

KARE DUVAR L BAĞLANTI  
SQUARE WLLA L  
CONNECTION





# 40 x 40 KARE AKSESUARLARI

## SQUARE 40 x 40 ACCESSORIES

KARE  
SQUARE  
Serisi



40-4001

40 x 40 ÜST BAĞLANTI TK D.G.  
40X40 CONNECTOR SET  
WITH JOINT (CAPPED)

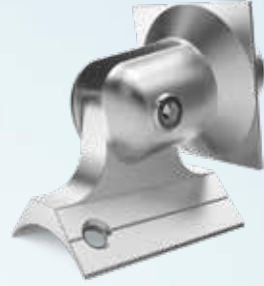

40-4002

40 x 40 ÜST BAĞLANTI TK  
40X40 CONNECTOR SET  
WITH JOINT



41-4003

40 x 40 SABİT MAFSAL D.G.  
40X40 CONNECTOR FITTING  
(CAPPED)



41-4004

40 x 40 SABİT MAFSAL  
40X40 CONNECTOR FITTING



41-4001

40 x 40 LAMALI SABİT MAFSAL  
40X40 CONNECTOR FITTING  
WITH JOINT FLAT

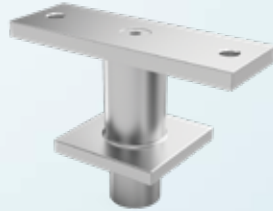

41-4002

40 x 40 LAMALI SABİT MAFSAL D.G.  
40X40 CONNECTOR SET WITH  
JOINT FLAT (CAPPED)



40-4003

40 x 40 LAMALI ÜST BAĞLANTI TK  
40X40 CONNECTOR FITTING  
WITH LAME

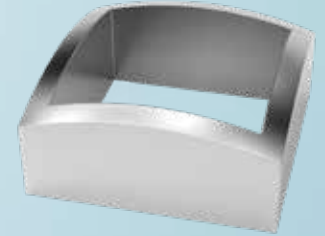

42-4001

40 x 40 DİKME FLANŞI  
40X40 GROUND FLANGE

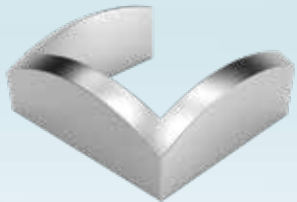

42-4002

40 x 40 DİKME FLANŞI U  
40X40 GROUND FLANGE U TYPE

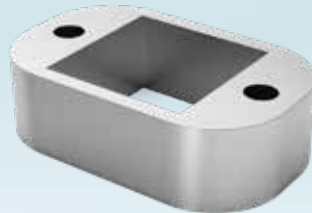

43-4001

40 x 40 DIŞTAN DUVAR FLANŞ  
40X40 GROUND FLANGE  
EXTERNALLY SCREWED



44-4002

40 x 40 KARE TAPA  
40X40 PLUG

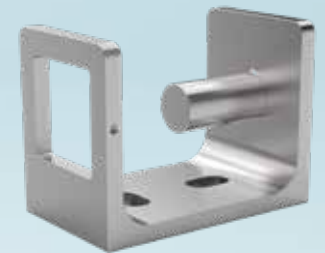

45-4001

40 x 40 YANDAN U BAĞLANTI  
40X40 SIDE WLLA  
CONNECTION U TYPE

# 60 x 25 KARE AKSESUARLARI

## SQUARE 60 x 25 ACCESSORIES

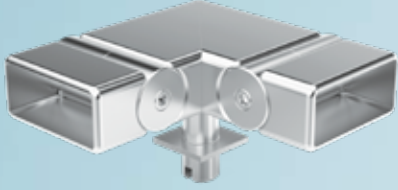

47-6016

60x25 DİRSEK VAZOLU 45-90-45  
60X25 ELBOW WITH BOTH SIDE  
MOVING 45-90-45

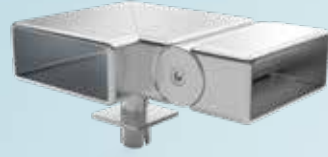

47-6015

60x25 DİRSEK VAZOLU 45-90  
60X25 ELBOW WITH ONE SIDE  
MOVING 45-90

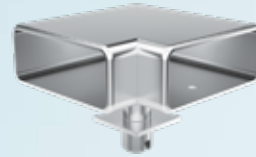

47-6014

60x25 DİRSEK VAZOLU 90  
60X25 ELBOW 90°



47-6003

60x25 DİRSEK 45-90-45  
60X25 ELBOW WITH BOTH  
SIDE MOVING 45-90-45

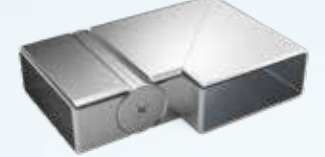

47-6002

60x25 DİRSEK 45-90  
60X25 ELBOW WITH ONE  
SIDE MOVING 45-90

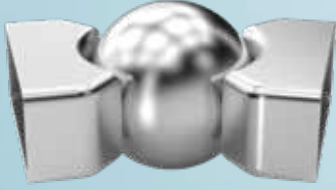

47-6005

60x25 KÜRE DİRSEK  
60X25 ELBOW WITH  
ADJUSTABLE MOVING

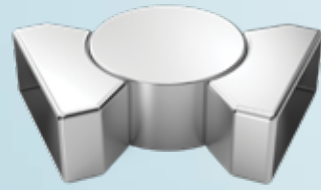

47-6004

60x25 YATAY DİRSEK  
60X25 ELBOW WITH  
HORIZONTAL MOVING



47-6001

60x25 AÇILI DİRSEK  
60X25 ELBOW WITH  
VERTICAL MOVING



47-6006

60x25 DİRSEK DİKEY  
60X25 FIXED  
ELBOW VERTICAL



43-6005

60x25 DUVAR FLANŞI DİKEY  
60X25 VERTICAL  
WALL FLANGE



43-6006

60x25 DUVAR FLANŞI YATAY  
60X25 ADJUSTABLE  
WALL FLANGE

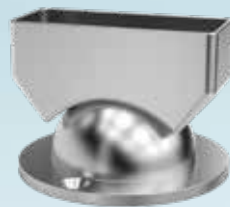

43-6007

60x25 DUVAR FLANŞI UFO  
60X25 ADJUSTABLE  
WALL FLANGE

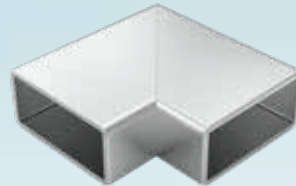

47-6008

60x25 KAPALI DİRSEK 90  
60X25 ELBOW 90°  
WITHOUT CHANNEL

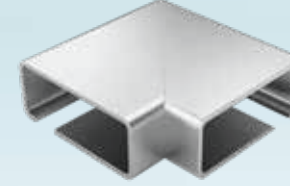

47-6009

60x25 Ö.KANAL DİRSEK 90  
60X25 ELBOW 90° WITH  
FRONT GLASS CHANNEL

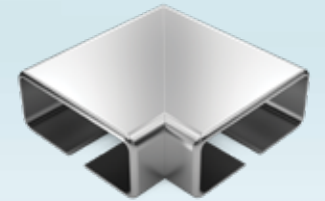

47-6010

60x25 O. KANAL DİRSEK 90  
60X25 ELBOW 90° WITH  
MIDDLE GLASS CHANNEL



# 60 x 25 KARE AKSESUARLARI

## SQUARE 60 x 25 ACCESSORIES

KARE  
SQUARE  
Serisi

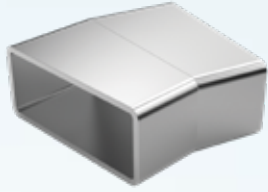

47-6011

60x25 KAPALI DİRSEK 45°  
60X25 ELBOW 45°  
WITHOUT CHANNEL

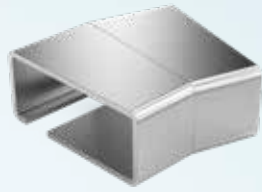

47-6012

60x25 Ö. KANAL DİRSEK 45°  
60X25 ELBOW 45° WITH  
FRONT GLASS CHANNEL

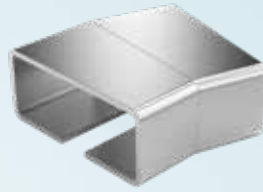

47-6013

60x25 O.KANAL DİRSEK 45°  
60X25 ELBOW 45° WITH  
MIDDLE GLASS CHANNEL



43-6008

60x25 DUVAR FLANŞI  
60X25 WALL FLANGE  
EXTERNALLY SCREWED

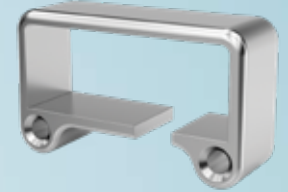

43-6009

60x25 DUVAR FLANŞI Ö. KANAL  
60X25 WALL FLANGE WITH  
FRONT GLASS CHANNEL

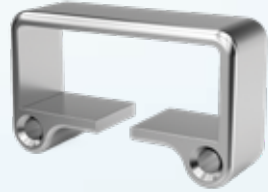

43-6010

60x25 DUVAR FLANŞI O. KANALI  
60X25 WALL FLANGE WITH  
MIDDLE GLASS CHANNEL

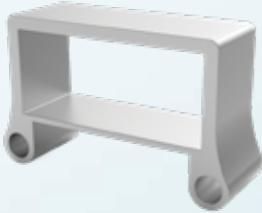

43-6001

60x25 DIŞTAN DUVAR FLANŞI  
60X25 WALL FLANGE  
EXTERNALLY SCREWED

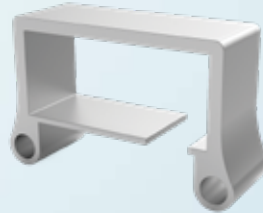

43-6002

60x25 DUVAR FLANŞI Ö. KANAL  
60X25 WALL FLANGE WITH  
FRONT GLASS CHANNEL

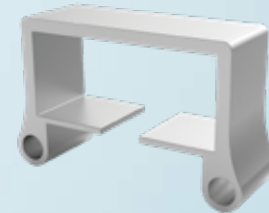

43-6003

60x25 DUVAR FLANŞI O. KANALI  
60X25 WALL FLANGE WITH  
MIDDLE GLASS CHANNEL

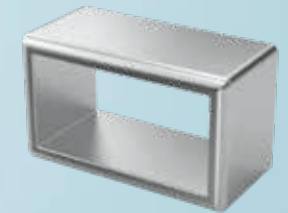

46-6001

60x25 BİLEZİK  
60X25 RING

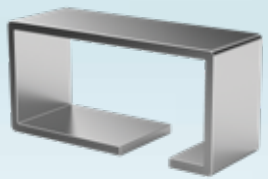

46-6002

60x25 BİLEZİK ÖNDEN KANALI  
60X25 RING WITH FRONT  
GLASS CHANNEL

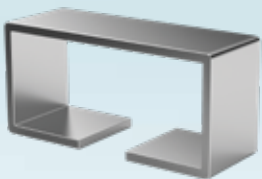

46-6003

60x25 BİLEZİK ORTADAN KANALI  
60X25 RING WITH MIDDLE  
GLASS CHANNEL

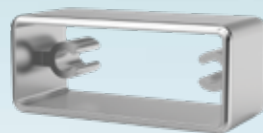

43-6004

60x25 İÇTEN V. DUVAR FLANŞI  
60X25 WALL FLANGE  
INTERNALLY SCREWED

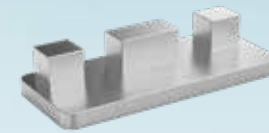

44-6002

60x25 İÇE GEÇME TAPA  
60X25 PLUG INTERNALLY

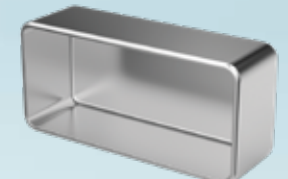

44-6001

60x25 TAPA DIŞA GEÇME  
60X25 PLUG EXTERNALLY

# 80 x 30 KARE AKSESUARLARI

metal & alüminyum

## SQUARE 80 x 30 ACCESSORIES

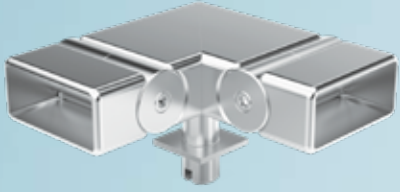

47-8006

80x30 DİRSEK VAZOLU 45-90-45  
80X30 ELBOW WITH BOTH  
SIDE MOVING 45-90-45

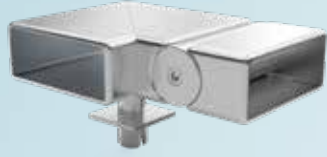

47-8005

80x30 DİRSEK VAZOLU 45-90  
80X30 ELBOW WITH ONE  
SIDE MOVING 45-90

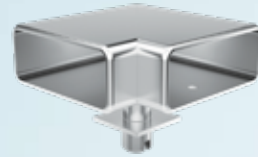

47-8004

80x30 DİRSEK VAZOLU 90  
80X30 ELBOW 90° WITH  
FRONT GLASS CHANNEL



47-8003

80x30 DİRSEK 45-90-45  
80X30 ELBOW WITH  
BOTH SIDE MOVING 45-90-45

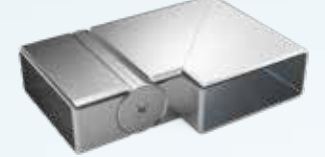

47-8002

80x30 DİRSEK 45-90  
80X30 ELBOW WITH ONE  
SIDE MOVING 45-90

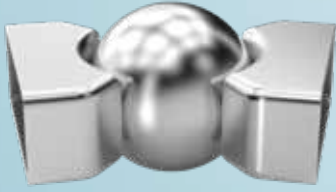

47-8016

80x30 KÜRE DİRSEK  
80X30 ELBOW WITH  
ADJUSTABLE MOVING

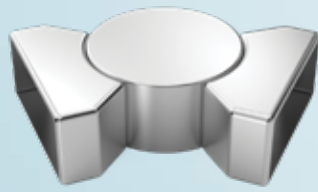

47-8014

80x30 YATAY DİRSEK  
80X30 ELBOW WITH  
HORIZONTAL MOVING



47-8001

80x30 DİRSEK DİKEY  
80X30 FIXED  
ELBOW VERTICAL



47-8015

80x30 AÇILI DİRSEK  
80X30 ELBOW WITH  
VERTICAL MOVING



43-8005

80x30 DUVAR FLANŞI DİKEY  
80X30 VERTICAL  
WALL FLANGE



43-8006

80x30 DUVAR FLANŞI YATAY  
80X30 ADJUSTABLE  
WALL FLANGE

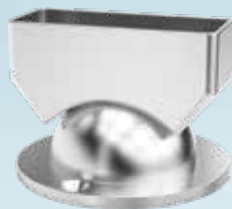

43-8007

80x30 DUVAR FLANŞI UFO  
80X30 ADJUSTABLE  
WALL FLANGE

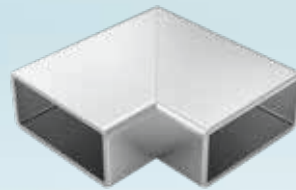

47-8007

80x30 KAPALI DİRSEK 90  
80X30 ELBOW 90°  
WITHOUT CHANNEL

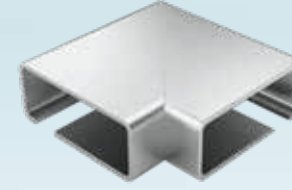

47-8008

80x30 O.KANAL DİRSEK 90  
80X30 ELBOW 90° WITH  
MIDDLE GLASS CHANNEL

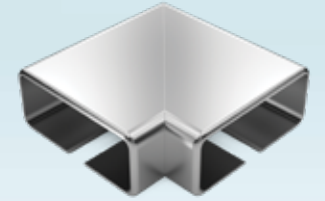

47-8009

80x30 Ö.KANAL DİRSEK 90  
80X30 ELBOW 90° WITH  
FRONT GLASS CHANNEL



# 80 x 30 KARE AKSESUARLARI

## SQUARE 80 x 30 ACCESSORIES

KARE  
SQUARE  
Serisi

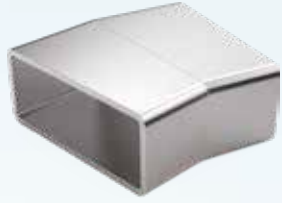

47-8011

80x30 KAPALI DİRSEK 45  
80X30 ELBOW 45°  
WITHOUT CHANNEL

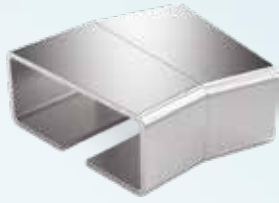

47-8012

80x30 O.KANAL DİRSEK 45  
80X30 ELBOW 45° WITH  
MIDDLE GLASS CHANNEL

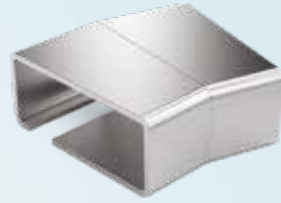

47-8013

80x30 Ö.KANAL DİRSEK 45  
80X30 ELBOW 45° WITH  
FRONT GLASS CHANNEL



43-8008

80x30 DUVAR FLANŞI  
80X30 WALL FLANGE  
EXTERNALLY SCREWED

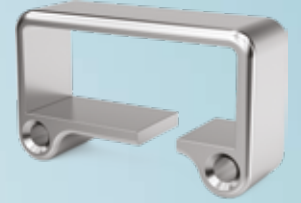

43-8009

80x30 DUVAR FLANŞI Ö.KANAL  
80X30 WALL FLANGE WITH  
FRONT GLASS CHANNEL

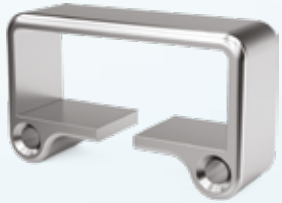

43-8010

80x30 DUVAR FLANŞI O.KANAL  
80X30 WALL FLANGE WITH  
MIDDLE GLASS CHANNEL

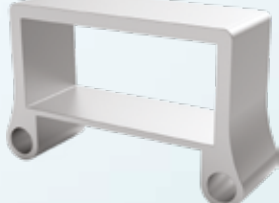

43-8001

80x30 DUVAR FLANŞI  
80X30 WALL FLANGE  
EXTERNALLY SCREWED

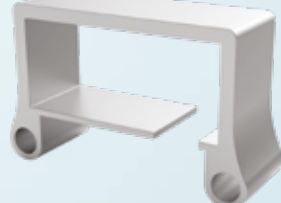

43-8002

80x30 DUVAR FLANŞI Ö.KANAL  
80X30 WALL FLANGE WITH  
FRONT GLASS CHANNEL

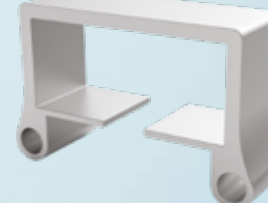

43-8003

80x30 DUVAR FLANŞI O.KANAL  
80X30 WALL FLANGE WITH  
MIDDLE GLASS CHANNEL

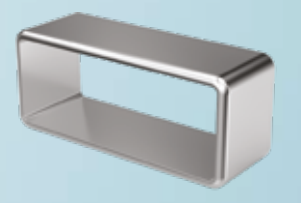

46-8001

80x30 BİLEZİK  
80X30 RING

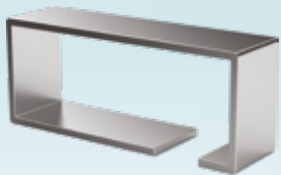

46-8002

80x30 BİLEZİK Ö.KANAL  
80X30 RING WITH FRONT  
GLASS CHANNEL

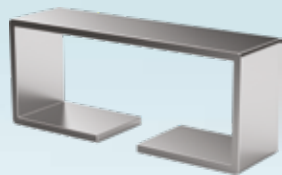

46-8003

80x30 BİLEZİK O.KANAL  
80X30 RING WITH MIDDLE  
GLASS CHANNEL



43-8004

80x30 İÇTEN V.DUVAR FLANŞI  
80X30 WALL FLANGE  
INTERNALLY SCREWED

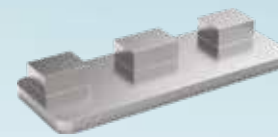

44-8002

80x30 İÇE GEÇME TAPA  
80X30 PLUG INTERNALLY

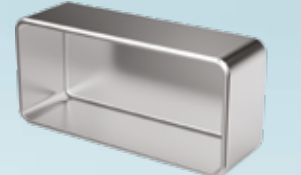

44-8001

80x30 TAPA DIŞA GEÇME  
80X30 PLUG EXTERNALLY

# 14 x 14 KARE AKSESUARLARI

## SQUARE 14 x 14 ACCESSORIES

metal & alüminyum



48-1404

14 x 14 HAREKETLİ DİRSEK  
DIŞA GEÇME  
14X14 MM VERTICAL  
ADJUSTABLE ELBOW



48-1403

14 x 14 HAREKETLİ DİRSEK  
İÇE GEÇME  
14X14 MM ADJUSTABLE  
ELBOW



48-1405

14 x 14 HAREKETLİ DİRSEK  
İÇE GEÇME PULLU  
14X14 MM ADJUSTABLE  
ELBOW WITH STAMP

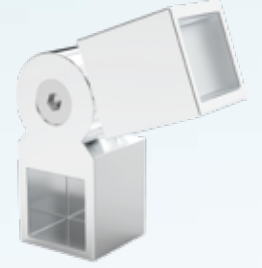

48-1406

14 x 14 HAREKETLİ DİRSEK  
14X14 MM ADJUSTABLE  
ELBOW

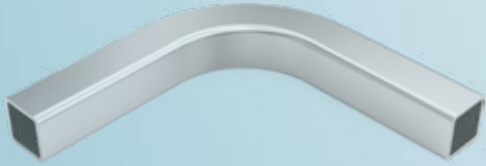

48-1401

14 x 14 KARE DİRSEK 90  
14X14 MM ELBOW 90°



48-1402

14 x 14 KARE DİRSEK 45  
14X14 MM ELBOW 45°



48-1407

14 x 14 HAREKETLİ DİRSEK  
14X14 MM ADJUSTABLE  
ELBOW



48-1410

14 \* 14 KARE BİLEZİK  
14X14 MM RING



44-1402

14 x 14 KARE MIZRAK TAPA  
14X14 MM DECORATIVE PLUG



44-1403

14 x 14 KARE BADEM TAPA  
14X14 MM DECORATIVE PLUG



44-1404

14 x 14 KARE PRAMİT TAPA  
14X14 MM DECORATIVE PLUG



44-1401

14 x 14 KARE TAPA  
14X14 MM PLUG



# 14 x 14 KARE AKSESUARLARI

## SQUARE 14 x 14 ACCESSORIES

KARE  
SQUARE  
Serisi



48-1444

14 \* 14 BORU TUTAMAĞI ÇİFT  
HAREKETLİ  
14X14 MM PIPE HANDLE WITH  
BOTH SIDE



48-1443

14 \* 14 BORU TUTAMAĞI  
HAREKETLİ  
14X14 MM PIPE HANDLE  
MOVING PLAIN



48-1440

14 \* 14 PİMLİ BORU TUTAMAĞI  
14X14 MM PIPE HANDLE



48-1441

14 \* 14 BORU TUTAMAĞI  
14X14 MM PIPE HANDLE

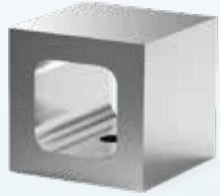

48-1442

14 \* 14 BORU TUTAMAĞI  
14X14 MM PIPE HANDLE



48-1445

14 X 14 PROFİL SPIDER CAM TUTUCU  
14X14 MM PIPE HANDLE WITH  
GLASS SPIDER



48-1420

14 x 14 KARE ALM VİDA  
GİZLEME  
SQUARE SCREW HIDDING



48-1430

14 X 14 JUMBO PROFİL  
14X14 MM JUMBO PIPE



# 16 x 22 - 30 x 25 KARE AKSESUARLARI

## SQUARE 16 x 22 - 30 x 25 ACCESSORIES



49-1601

16 x 22 DİRSEK 90°  
16X22 MM ELBOW 90°



49-1602

16 x 22 DİRSEK 45°  
16X22 MM ELBOW 45°



49-1610

16 x 22 BİLEZİK  
16X22 MM RING



49-1621

16 x 22 DIŞA GEÇME TAPA  
16X22 MM PLUG



49-1622

16 x 22 DUVAR FLANŞI  
16X22 MM WALL FLANGE



50-3001

30 x 25 DİRSEK 90°  
30X25 MM ELBOW 90°

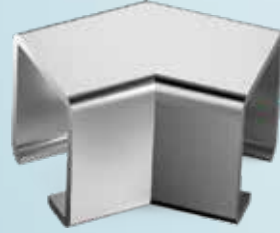

50-3002

30 x 25 DİRSEK 45°  
30X25 MM ELBOW 45°

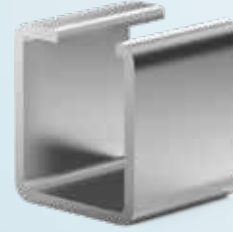

50-3003

30 x 25 BİLEZİK  
30X25 MM RING



50-3004

30 x 25 DIŞA GEÇME TAPASI  
30X25 PLUG EXTERNALLY



50-3006

30 x 25 DUVAR FLANŞI  
30X25 MM WALL FLANGE

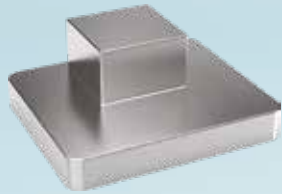

50-3005

30 x 25 İÇE GEÇME TAPASI  
30X25 PLUG INTERNALLY





# KARE DİKME AKSESUARLARI

## SQUARE STRUTS ACCESSORIES

KARE  
SQUARE  
Serisi



13-1001

100 LİK BAŞLANGIÇ TOPUZU  
100' KNOB PLUG



13-8501

85 x 85 BAŞLANGIÇ TOPUZU  
85X85 KNOB PLUG

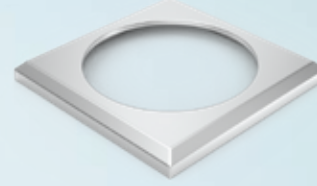

51-7001

70 X 70 ÜST TAPA  
70X70 MM PERFORATED COVER

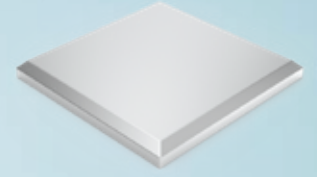

51-7002

70 X 70 ÜST TAPA  
70X70 MM PERFORATED COVER



51-1002

100 X 100 DELİKLİ TAPA  
100X100 MM PERFORATED  
COVER

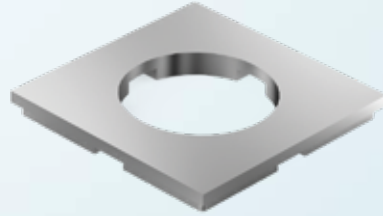

51-1003

100 X 100 ÜST TAPA  
100X100 MM PERFORATED  
COVER



42-7001

70 x 70 DİKME FLANŞ  
70 x 70 MM GROUND FLANGE



42-8501

85 x 85 DİKME FLANŞ  
85 x 85 MM GROUND FLANGE



42-1001

100 x 100 DİKME FLANŞ  
100 x 100 MM GROUND  
FLANGE

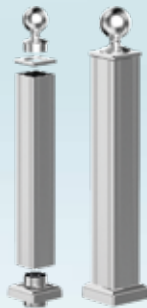

52-7001

70 X 70 BABA DİKME SETİ  
70X70 STRUT PROFILE SET



52-8501

85 X 85 BABA DİKME SETİ  
85X85 STRUT PROFILE SET



52-1001

100 X 100 BABA DİKME SETİ  
100X100 STRUT PROFILE SET

# YUVARLAK 35' GRUP AKSESUARLARI

## ROUND 35' GROUP ACCESSORIES



01-3502

35 LİK ÜST BAĞLANTI TK  
Ø35' CONNECTOR SET WITH JOINT

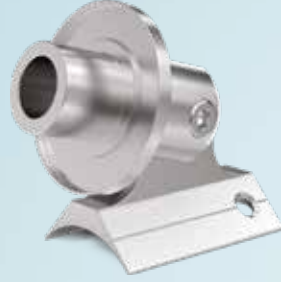

01-3503

35' LİK ÜST BAĞLANTI TK D.G.  
Ø35' CONNECTOR SET WITH JOINT



03-3501

35 LİK SABİT MAFSAL  
Ø35' CONNECTOR FITTING



02-3502

35 LİK AYAK DOLU  
Ø35' GROUND FLANGE (FULL)



02-3501

35 LİK AYAK  
Ø35' GROUND FLANGE (EMPTY)



12-3501

35 LİK DUVAR FLANŞI  
Ø35' WALL FLANGE



12-3502

35 LİK D.VİDALI DUVAR FLANŞI  
Ø35' WALL FLANGE EXTERNALLY SCR.



14-3501

35 LİK DEKORLU FLANŞ  
Ø35' DECORATIVE FLANGE



11-3501

35 LİK BİLEZİKLİ DOLU  
TOPUZ DİRSEK  
Ø35' FITTING SPHERE ELBOW

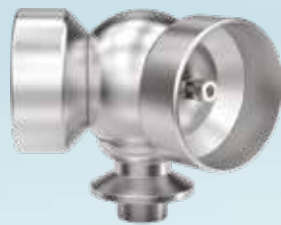

11-3502

35 LİK KADEHLİ  
TOPUZ DİRSEK  
Ø35' FITTING SPHERE  
ELBOW SET



11-3503

35 LİK EKONOMİK KADEHLİ  
TOPUZ DİRSEK  
Ø35' FITTING SPHERE  
ELBOW SET(ECO.)



06-3501

35 LİK TAPA  
Ø35' PLUG



# YUVARLAK 35' GRUP AKSESUARLARI

## ROUND 35' GROUP ACCESSORIES

YUVARLAK  
ROUND  
Serisi



04-5005

35 x 50 KURTAĞZI  
Ø35X50' SLOTTED JOINT



04-5006

35 x 35 KURTAĞZI  
Ø35X35' SLOTTED JOINT

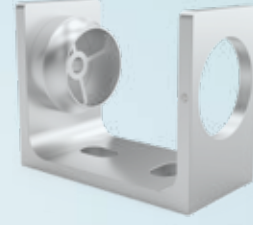

15-3501

35 LİK YANDAN U BAĞLANTI  
Ø35' SIDE WALL CONNECTION U TYPE



13-3501

35 LİK BAŞLANGIÇ TOPUZ  
Ø35' KNOB PLUG



# YUVARLAK 40' GRUP AKSESUARLARI

## ROUND 40' GROUP ACCESSORIES



01-4001

40 LIK ÜST BAĞLANTI TAKIM  
Ø40' CONNECTOR SET  
WITH JOINT

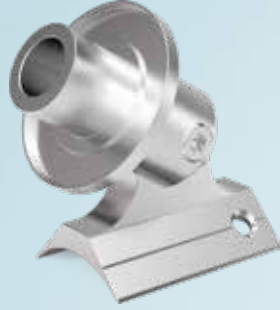

01-4002

40 LIK ÜST BAĞLANTI D.G.  
Ø40' CONNECTOR SET  
WITH JOINT (CAPPED)



01-4003

40 LIK ÜST BAĞLANTI D.G.  
Ø40' CONNECTOR SET WITH  
JOINT (CAPPED-PATTERNED)



03-4001

40 LIK SABİT MAFSAL  
Ø40' CONNECTOR FITTING



03-4003

40 LIK BÜYÜK SABİT MAFSAL D.G.  
Ø40' CONNECTOR FITTING  
(CAPPED)-BIG MODEL



04-4001

40 X 40 KURT AĞZI  
Ø40x40' CONNECTOR  
FITTING

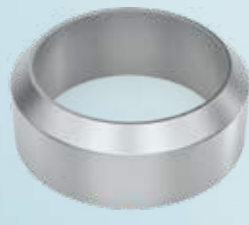

02-4004

40 LIK DİKME FLANŞI TIRNAKSIZ  
Ø40' GROUND FLANGE  
WITHOUT TOOTH

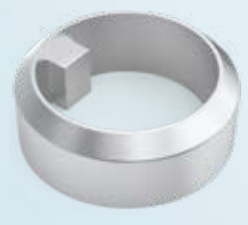

02-4001

40 LIK DİKME FLANŞI TEK T.  
Ø40' GROUND FLANGE  
ONE TOOTH



02-4005

40 LIK DİKME F. TIRNAKSIZ  
Ø40' GROUND FLANGE  
PATTERNED WITHOUT TOOTH



02-4006

40 LIK DİKME F. TEK TIRNAK  
Ø40' GROUND FLANGE  
PATTERNED WITH ONE TOOTH



04-4002

40 X 50 KURT AĞZI  
Ø40x50' CONNECTOR  
FITTING



02-4003

40 LIK DEKORLU DİKME F.  
Ø40' GROUND FLANGE  
PATTERNED



02-4002

40' LIK DİKME FLANŞ UZUN  
Ø40' LONG GROUND FLANGE



15-4010

40 LIK UZATMA APARATI  
Ø40' EXTENSION APPARATUS

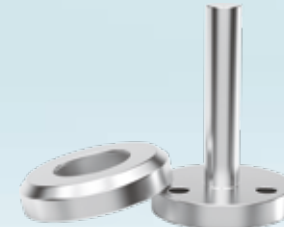

02-4007

40 LIK ANGREAJ D.F. KAPAKLI  
Ø40' SUPPORT FLANGE WITH  
ANCHOR-INTERNAL (8CM)



02-4008

40 LIK DİKME FLANŞI KAPAKLI  
Ø40' EXTERNAL  
SUPPORT FLANGE



# YUVARLAK 40' GRUP AKSESUARLARI

## ROUND 40' GROUP ACCESSORIES

YUVARLAK  
ROUND  
Serisi



11-4001

40 LİK KADEHLİ T. DİRSEK  
Ø40' FITTING SPHERE  
ELBOW SET (FULL)



11-4002

40 LİK EKO KADEHLİ T. DİRSEK  
Ø40' FITTING SPHERE ELBOW  
SET(ECO.) EMPTY



12-4001

40 LİK D.V. DUVAR FLANŞI  
Ø40' GROUND FLANGE  
EXTERNALLY SCREWED



12-4005

40 LİK D.V. DUVAR FLANŞI UZUN  
Ø40' GROUND FLANGE  
EXTERNALLY SCREWED (LONG)



12-4004

40 LİK FLANŞ KAPAĞI  
Ø40' GROUND FLANGE  
COVER



12-4002

40 LİK DUVAR FLANŞ  
Ø40' GROUND FLANGE  
SINGLE HOLE



12-4003

40 LİK DUVAR FLANŞ ÇİFTLİ  
Ø40' WALL FLANGE  
(DOUBLE HOLES)



14-4001

40 LİK DEKORLU FLANŞ  
Ø40' DECORATIVE FLANGE



14-4002

40 LİK DEKORLU FLANŞ ÇAM  
Ø40' PATTERNED FLANGE



14-4003

40 LİK DEKORLU FLANŞ  
Ø40' PATTERNED FLANGE



13-4001

40 LİK BAŞLANGIÇ TOPUZU  
Ø40' KNOB PLUG

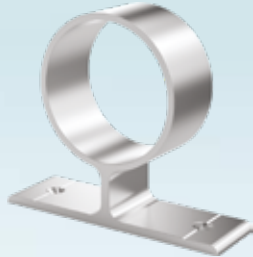

15-4001

40 LİK DUVAR DİBİ T  
Ø40' T WLLA CON. T



15-4003

40 LİK UZUN DUVAR DİBİ T  
Ø40' T WLLA CON. T LONG



15-4002

40 LİK YANDAN U BAĞLANTI  
Ø40' SIDE WLLA  
CONNECTION U TYPE

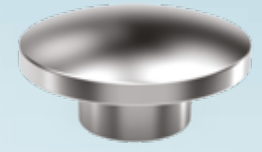

06-4001

40 LİK TAPA  
Ø40' PLUG

# YUVARLAK 50' GRUP AKSESUARLARI

## ROUND 50' GROUP ACCESSORIES



01-5001

50 LİK ÜST BAĞLANTI TK D.G.  
Ø50' CONNECTOR SET  
WITH JOINT



01-5003

50 LİK ÜST BAĞLANTI TK DESENİ D.G.  
Ø50' CONNECTOR SET  
WITH JOINT (PATTERNED)



01-5004

50 LİK HAREKETLİ LAMALI BAŞLIK  
Ø50' ADJUSTABLE WALL  
CONNECTOR SET



04-5001

50 LİK KURTAĞZI BAĞLANTI  
Ø50X50' SLOTTED JOINT



12-5003

50 LİK G. DUVAR FLANŞI (UFO)  
Ø50' ADJUSTABLE WALL  
FLANGE WITH COVER



12-5001

50 LİK D.V. DUVAR FLANŞI  
Ø50' GROUND FLANGE  
EXTERNALLY SCREWED



12-5009

50 LİK D.V. FLANŞI UZUN  
Ø50' GROUND FLANGE  
EXTERNALLY SCR. (LONG)

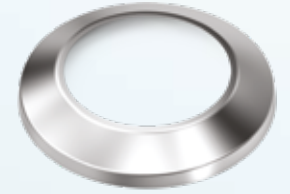

12-5002

50 LİK FLANŞ KAPAĞI  
Ø50' GROUND FLANGE COVER



12-5007

50 LİK DUVAR FLANŞI Ç.DELİKLİ  
Ø50' WALL FLANGE  
DOUBLE HOLES



12-5005

50 LİK DUVAR FLANŞI T. DELİKLİ  
Ø50' GROUND FLANGE  
SINGLE HOLE



02-5002

50 LİK YER FLANŞI  
Ø50' GROUND FLANGE EMPTY



02-5003

50 LİK YER FLANŞI DEKORLU  
Ø50' GROUND FLANGE  
PATTERNED



# YUVARLAK 50' GRUP AKSESUARLARI

## ROUND 50' GROUP ACCESSORIES

YUVARLAK  
ROUND  
Serisi



11-5003

50 LİK DOLU TOPUZ DİRSEK  
Ø50' SPHERE ELBOW



11-5004

50 LİK EKO TOPUZ DİRSEK  
Ø50' SPHERE ELBOW (ECO.)



11-5005

50 LİK BOŞ TOPUZ DİRSEK  
Ø50' EMPTY KNOB ELBOW  
SINGLE SIDED MOVING



02-5001

50 LİK AYAK DOLU  
Ø50' GROUND FLANGE (FULL)



11-5001

50 LİK ŞİŞME DİRSEK 90  
Ø50' INFLATE BEND 90°



11-5002

50 LİK ŞİŞME DİRSEK 45  
Ø50' INFLATE BEND 45°

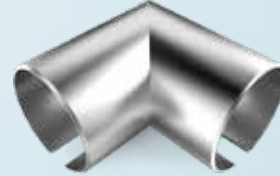

11-5009

50 LİK CAM KANALLI DİRSEK 90  
Ø50' BEND WITH GLASS  
CHANNEL 90°



11-5010

50 LİK CAM KANALLI DİRSEK 45  
Ø50' BEND WITH GLASS  
CHANNEL 45°



05-5001

50 LİK BİLEZİK (3CM)  
Ø50' RING (3CM)



05-5002

50 LİK UZUN BİLEZİK (5CM)  
Ø50' RING (5CM)



05-5003

50 LİK BAĞLANTI TAKOZU  
Ø50' PIPE ANCHOR  
CONNECTOR

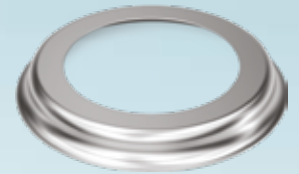

12-5004

50 LİK DUVAR ROZETİ  
Ø50' FLANGE COVER

# YUVARLAK 50' GRUP AKSESUARLARI

## ROUND 50' GROUP ACCESSORIES



13-5002

50 LİK KRİSTAL TOPUZ  
Ø50' CRYSTAL KNOB



13-5001

50 LİK BAŞLANGIÇ TOPUZU  
Ø50' KNOB PLUG



04-5002

50 LİK DELİKLİ TAPA  
Ø50' PERFORATED PLUG



04-5003

50 LİK PUL I  
Ø50' STAMP



06-5001

50 LİK BOŞ TAPA  
Ø50' PLUG (ECO)

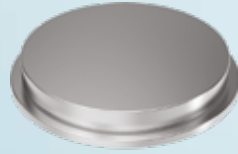

06-5002

50 LİK TAPA  
Ø50' PLUG

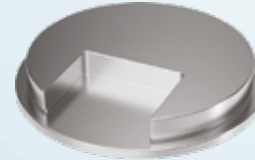

06-5003

50 LİK TAPA CAM KANALLI  
Ø50' PLUG FOR GLASS  
CHANNELED

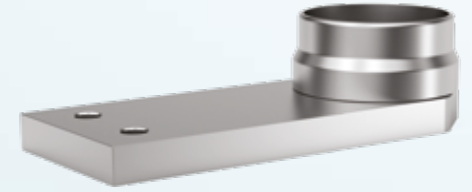

15-5004

50 LİK DİKME UZATMA APARATI  
Ø50' PILLAR EXTENSION  
APPARATUS

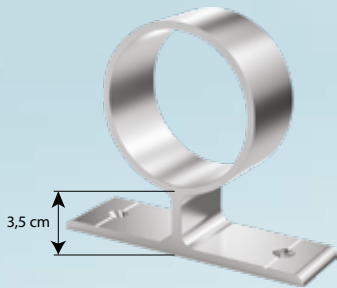

15-5001

50 LİK DUVAR DİBİ BAĞLANTI T  
Ø50' T WLLA CONNECTION

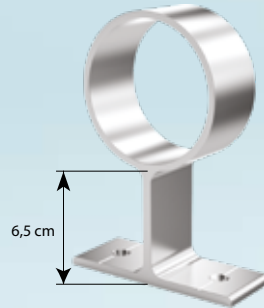

15-5002

50 LİK DUVAR DİBİ BAĞLANTI T (ORTA)  
Ø50' T WLLA CONNECTION (MIDDLE)

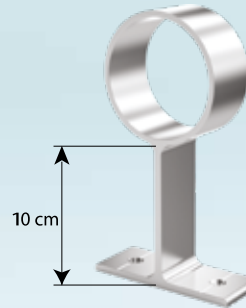

15-5003

50 LİK DUVAR DİBİ BAĞLANTI T (UZUN)  
Ø50' T WLLA CONNECTION (LONG)

# YUVARLAK 65' GRUP AKSESUARLARI

## ROUND 65' GROUP ACCESSORIES

YUVARLAK  
ROUND  
Serisi



13-6501

65 LİK KRİSTAL TOPUZ  
Ø65' CRYSTAL KNOB



13-6503

65 LİK BAŞLANGIÇ TOPUZU  
Ø65' KNOB PLUG



02-6501

65 LİK YER FLANŞI KALIN  
Ø65' GROUND FLANGE



02-6502

65 LİK YER FLANŞI  
Ø65' GROUND FLANGE (ECO)



02-8001

80 LİK YER FLANŞI  
Ø80' GROUND FLANGE (ECO)



02-1001

100 LUK YER FLANŞI  
Ø100' GROUND FLANGE (ECO)



05-6501

65 LİK BAĞLANTI TAKOZU  
Ø65' PIPE ANCHOR CONNECTOR





# YUVARLAK 16' GRUP AKSESUARLARI

## ROUND 16' GROUP ACCESSORIES



09-1601

16' LIK BORU TUTAMAĞI PARÇALI  
Ø16' PIPE HANDLE SET



09-1607

16 LIK DİKEY BORU TUTAMAĞI  
Ø16x16 PIPE VERTICAL  
BARRIER HOLDER



09-1608

16 LIK BORU TUTAMAĞI  
ÇİFT TARAFLI  
Ø16' DOUBLE PIPE  
HANDLE SET



09-1602

16 LIK BORU TUTAMAĞI PİMLİ  
Ø16' PIPE HANDLE



09-1603

16' LIK BORU TUTAMAĞI  
PİMSİZ DESENSİZ  
Ø16' PIPE HANDLE



09-1609

16' LIK BORU TUTAMAĞI  
PİMSİZ DESENİ  
Ø16' PIPE HANDLE



09-1610

16 LIK BORU TUTAMAĞI PİMLİ  
Ø16' PIPE HANDLE



09-1611

16 LIK BORU TUTAMAĞI  
Ø16' PIPE HANDLE

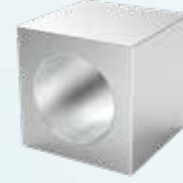

09-1606

16 LIK BORU TUTAMAĞI  
DİŞ KARE 23 x 23 mm  
Ø16' PIPE HANDLE



09-1605

16 LIK SERİT ARA DEKOR  
Ø16' SINGLE DECORATIVE  
SPHERE



14-1603

16 LIK DEKORLU TEK  
BOĞUM DESENİ  
Ø16' SINGLE  
DECORATIVE SPHERE



14-1601

16 LIK DEKORLU FLANŞ  
Ø16' PATTERNED  
SERRATED FLANGE



14-1602

16 LIK DEKORLU  
FLANŞ BOĞUMLU  
Ø16' PATTERNED  
SERRATED FLANGE



14-1604

16 LIK DEKORLU  
BAĞDAT MODELİ  
Ø16' PATTERNED  
SERRATED FLANGE



14-1605

16 LIK DEKORLU ORTA  
BOĞUM MODELİ  
Ø16' PATTERNED SERRATED  
FLANGE



06-1601

16 LIK TAPA  
Ø16' PLUG



06-1602

16 LIK BADEM TAPA  
Ø16' CANDLE PLUG



06-1603

16 LIK MIZRAK TAPA  
Ø16' DOMED PLUG



06-1604

16 LIK TOPUZ TAPA  
Ø16' KNOB PLUG



06-1605

16 LIK KÜRE TAPA  
Ø16' END PLUG

# YUVARLAK 16' GRUP AKSESUARLARI

## ROUND 16' GROUP ACCESSORIES

YUVARLAK  
ROUND  
Serisi



08-1603

16 LIK HAREKETLİ DİRSEK  
Ø16' SPHERE ELBOW



08-1601

16 LIK DİRSEK 90  
Ø16' SPHERE ELBOW  
BEND 90°



08-1602

16 LIK DİRSEK 45  
Ø16' SPHERE ELBOW  
BEND 45°



05-1601

16 LIK BİLEZİK  
Ø16' RING (5CM)



04-1601

16 LIK PUL  
Ø16' PIPE STAMP



04-1602

16 x 40 HAREKETLİ BAĞLANTI  
Ø16x40' MOVING CONNECTION



12-1603

16 LIK HAREKETLİ  
DUVAR FLANŞI  
Ø16' ADJUSTABLE WALL FLANGE



12-1601

16 LIK DUVAR FLANŞI  
Ø16' WALL FLANGE



04-1607

16 x 40 KURTAZĞI  
Ø16x40' SLOTTED JOINT



12-1602

16 LIK DIŞTAN DUVAR FLANŞI  
Ø16' WALL FLANGE  
EXTERNALLY SCREWED



10-1601

16 LIK BORU CAM SPİDER  
Ø16' PIPE GLASS CONNECTOR



07-1602

16 LIK PLASTİK VİDA GİZLEME  
Ø16' PLASTIC SCREW  
HIDDING



07-1601

16 LIK ALÜMİNYUM VİDA GİZLEME  
Ø16' ALUMINIUM SCREW HIDDING



18-1601

16 LIK JUMBO  
Ø16' JUMBO PIPE

# YUVARLAK 19' GRUP AKSESUARLARI

## ROUND 19' GROUP ACCESSORIES

metal & alüminyum



08-1903

19 LUK HAREKETLİ  
Ø19' SPHERE ELBOW



08-1901

19 LUK 90° DİRSEK  
Ø19' SPHERE ELBOW  
BEND 90°



08-1902

19 LUK 45° DİRSEK  
Ø19' SPHERE ELBOW  
BEND 45°



12-1901

19 LUK DUVAR FLANŞI  
Ø19' WALL FLANGE



12-1902

19 LUK DUVAR FLANŞI D.V.  
Ø19' WALL FLANGE  
EXTERNALLY SCREWED

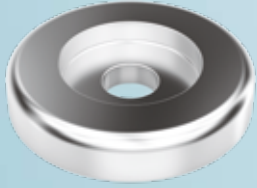

04-1901

19 LUK PUL  
Ø19' PIPE STAMP



14-1901

19 LUK DESENLİ FLANŞ  
Ø19' PATTERNED  
SERRATED FLANGE



14-1902

19 LUK DESENLİ FLANŞ  
Ø19' PATTERNED  
SERRATED FLANGE



05-1901

19 LUK BİLEZİK  
Ø19' RING (5CM)



06-1901

19 LUK TAPA  
Ø19' PLUG



07-1901

19 LUK ALM. VİDA GİZLEME  
Ø19' ALUMINIUM SCREW  
HIDDING



07-1902

19 LUK PLS. VİDA GİZLEME  
Ø19' PLASTIC SCREW  
HIDDING



07-1903

19 LUK KRM. VİDA GİZLEME  
Ø19' STEEL SCREW HIDDING



06-1903

19 LUK TOPUZ  
Ø19' KNOB PLUG



18-1901

19 LUK JUMBO  
Ø19' JUMBO PIPE



# ORTAK ÜRÜNLER

## COMMON PRODUCTS



20-1001

ÇAMAŞIRLIK  
ALUMINIUM LAUNDRY



20-1002

MENTEŞELİ ÇAMAŞIRLIK  
ALUMINIUM LAUNDRY



20-1003

LÜKS ÇAMAŞIRLIK  
ALUMINIUM LAUNDRY (LUX)



20-1004

PVC DOĞRAMA ÇAMAŞIRLIK  
ALUMINIUM LAUNDRY



20-1005

KATLANIR ÇAMAŞIRLIK  
ALUMINIUM LAUNDRY



20-1006

DUVARA MONTE ÇAMAŞIRLIK  
ALUMINIUM LAUNDRY



20-1007

KÖŞELİ PROLİF ÇAMAŞIRLIK  
ALUMINIUM LAUNDRY



20-6001

KARE ÇAMAŞIRLIK 60 \* 25  
SQUARE ALUMINIUM  
LAUNDRY 60X25



20-8001

KARE ÇAMAŞIRLIK 80 \* 30  
SQUARE ALUMINIUM  
LAUNDRY 80X30



19-1602

16 & 19 LİK BÜKÜM MAKİNASI  
Ø16-19' MANUAL PIPE  
BENDER



19-5001

50 LİK BORU BÜKME  
MAKİNASI  
Ø50' ELECTRICAL PIPE  
BENDER (BIG)



19-5002

50 LİK BORU BÜKME  
MAKİNASI KÜÇÜK  
Ø50' ELECTRICAL PIPE  
BENDER (SMALL)

# ORTAK ÜRÜNLER

## COMMON PRODUCTS

metal & alüminyum



10-4001

FİTİLLİ BÜYÜK CAM KLİPSİ YENİ  
ROUND BIG GLASS HOLDER



10-4002

KARE FİTİLLİ CAM KLİPSİ  
SQUARE GLASS HOLDER



10-3507

OVAL FİTİLLİ CAM KLİPSİ  
ROUND GLASS HOLDER



10-3505

FİTİLLİ KAPAKLI CAM KLİPSİ  
ROUND GLASS HOLDER



10-3506

FİTİLLİ KAPAKLI CAM KLİPSİ  
ROUND GLASS HOLDER



10-4003

YATAY CAM KLİPSİ - VİLADLI  
HORIZONTAL GLASS HOLDER



10-3510

FİTİLLİ CAM KLİPSİ TEK VİDA  
GLASS HOLDER SINGLE SCREW



10-3501

CAM KLİPSİ  
ROUND GLASS HOLDER



10-3502

40° LİK ÜST BAĞLANTI  
DIŞA GEÇME  
Ø40° CONNECTOR SET WITH  
JOINT (CAPPED)

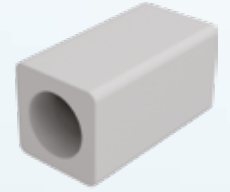

10-3503

CAM KLİPS STOBU  
GLASS WEDGE PLASTIC



15-1002

DUVAR L BAĞLANTI 45°  
WALL SIDE CONNECTOR 45°

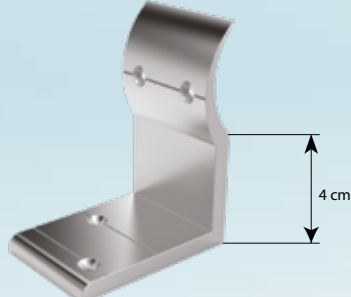

15-1003

DUVAR L BAĞLANTI 90°  
WALL SIDE CONNECTOR 90°

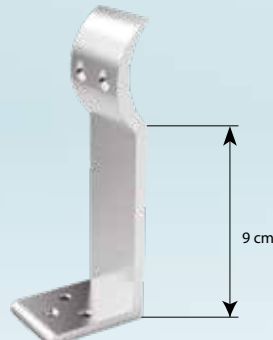

15-1004

DUVAR L BAĞLANTI UZUN  
WALL SIDE CONNECTOR  
90° LONG



15-1001

DUVAR Y BAĞLANTI  
WALL Y CONECTOR



10-3504

CAM PLASTİÇİ  
GLASS CLIP PLASTIC

# ORTAK ÜRÜNLER

## COMMON PRODUCTS



15-1005

DUVAR YANDAN BAĞLANTI TK  
Ø50 WALL SIDE CONNECTOR  
(ECO.)

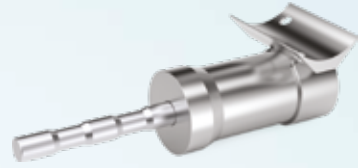

15-5005

DUVAR YANDAN BAĞLANTI  
TK ANGRAJLI  
Ø50 WALL SIDE CONNECTOR



16-1010

KORKULUK MENTEŞE  
ALUMINIUM HINGE

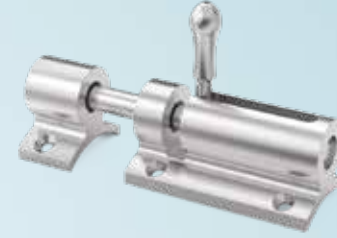

16-1011

KORKULUK SÜRGÜ  
ALUMINIUM SLIDE



17-3505

PLASTİK SABİTLEME  
PLASTIC FIXING



17-4002

ANGREYAJ DEMİRİ  
15 cm DOLU  
ANCHOR 15 CM FILLED



17-4001

ANGREYAJ DEMİRİ  
20 cm DOLU  
ANCHOR 20 CM FILLED



17-4007

ANGREYAJ DEMİRİ  
30 cm DOLU  
ANCHOR 30 CM FILLED



17-4008

ANGREYAJ DEMİRİ  
40 cm DOLU  
ANCHOR 40 CM FILLED

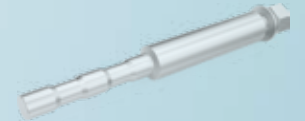

17-4003

VİDALI ANGREYAJ DEMİRİ  
ANCHOR 20 CM SCREWED



17-4006

BOŞ ANGREYAJ 15 cm  
ANCHOR 15 CM EMPTY



17-4005

BOŞ ANGREYAJ 20 cm  
ANCHOR 20 CM EMPTY



17-4004

BOŞ ANGREYAJ 40 cm  
ANCHOR 30 CM EMPTY



17-3503

GİJON MİLİ 8 METRİK 120 CM  
8 MM CIJON 120 CM



17-3501

GİJON MİLİ 8 METRİK 100 CM  
8 MM CIJON 100 CM



# PROFILLER PROFILES

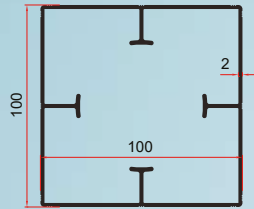

**PRF 0001**

2,700 KG/MT

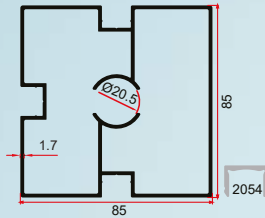

**PRF 0002**

2,300 KG/MT

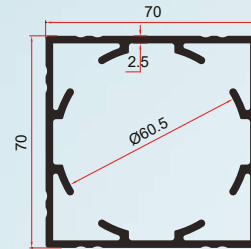

**PRF 0003**

2,422 KG/MT

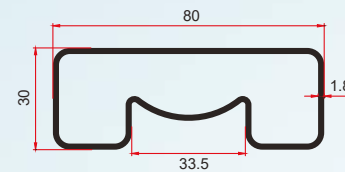

**PRF 0004**

1,123 KG/MT

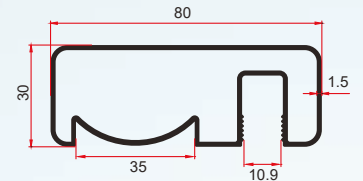

**PRF 0005**

1,069 KG/MT

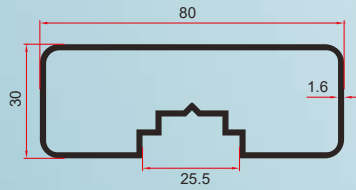

**PRF 0006**

0,990 KG/MT

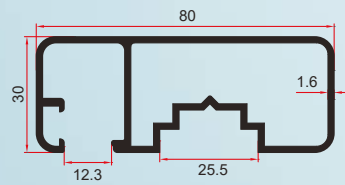

**PRF 0007**

1,110 KG/MT

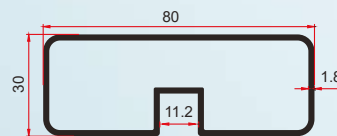

**PRF 0008**

1,192 KG/MT

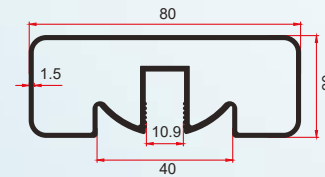

**PRF 0009**

1,137 KG/MT

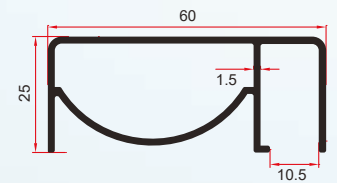

**PRF 0010**

0,744 KG/MT

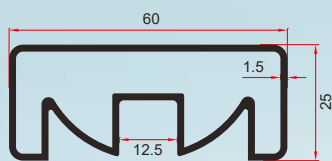

**PRF 0011**

0,880 KG/MT

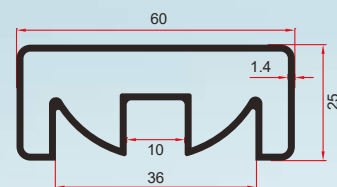

**PRF 0074**

0,825 KG/MT

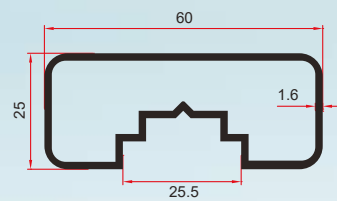

**PRF 0013**

0,780 KG/MT

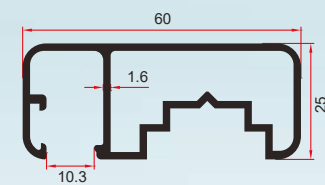

**PRF 0014**

0,864 KG/MT

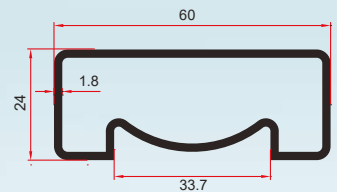

**PRF 0015**

0,839 KG/MT

# PROFILLER PROFILES

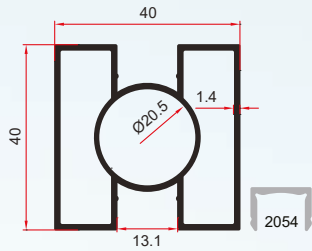

**PRF 0016**

0,900 KG/MT

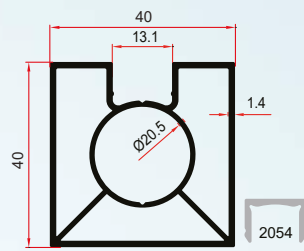

**PRF 0017**

0,972 KG/MT

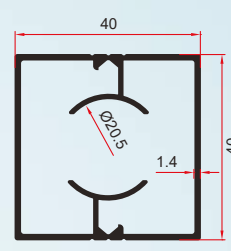

**PRF 0018**

0,809 KG/MT

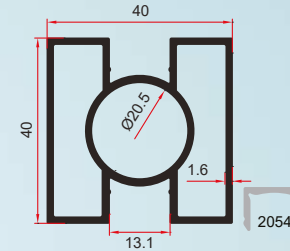

**PRF 0019**

1,040 KG/MT

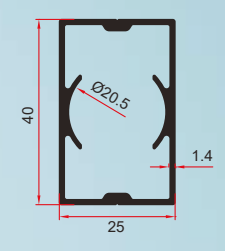

**PRF 0020**

0,619 KG/MT

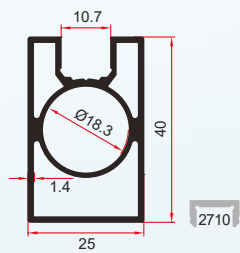

**PRF 0021**

0,778 KG/MT

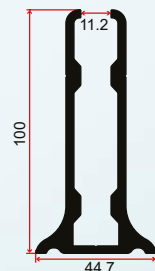

**PRF 0025**

2,385 KG/MT

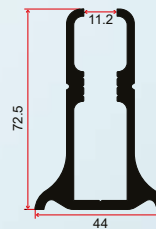

**PRF 0026**

1,590 KG/MT



**PRF 0027**

1,576 KG/MT

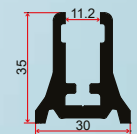

**PRF 0040**

0,957 KG/MT

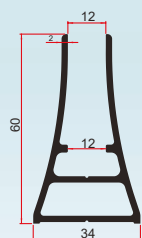

**PRF 0028**

1,002 KG/MT

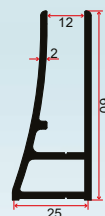

**PRF 0029**

0,892 KG/MT

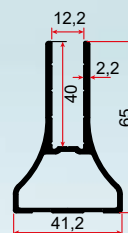

**PRF 0030**

0,972 KG/MT

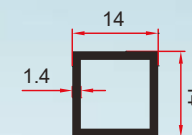

**PRF 0023**

0,190 KG/MT

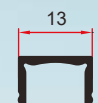

**PRF 0024**

0,090 KG/MT

# PROFILLER PROFILES

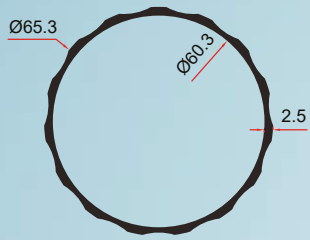

**PRF 0057**

1,090 KG/MT

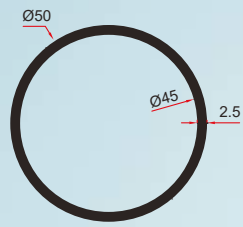

**PRF 0051**

0,658 KG/MT

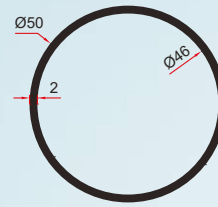

**PRF 0052**

0,815 KG/MT

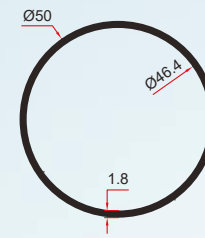

**PRF 0053**

0,740 KG/MT

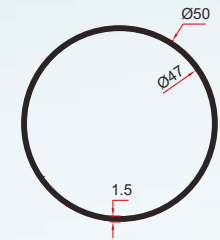

**PRF 0054**

0,620 KG/MT

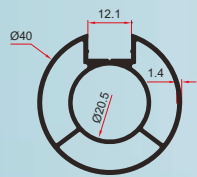

**PRF 0059**

0,772 KG/MT

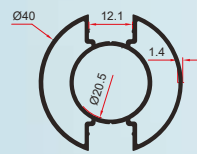

**PRF 0060**

0,730 KG/MT

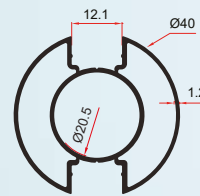

**PRF 0061**

0,655 KG/MT

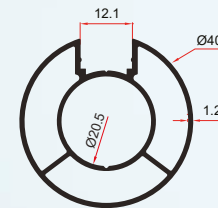

**PRF 0062**

0,735 KG/MT

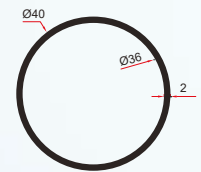

**PRF 0058**

0,267 KG/MT

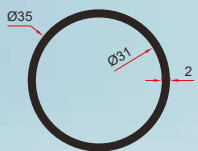

**PRF 0064**

0,562 KG/MT

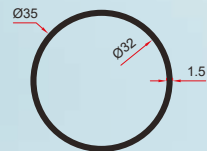

**PRF 0065**

0,430 KG/MT

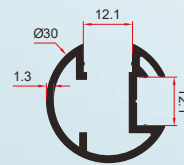

**PRF 0066**

0,440 KG/MT

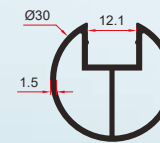

**PRF 0067**

0,155 KG/MT

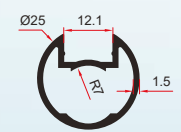

**PRF 0068**

0,135 KG/MT

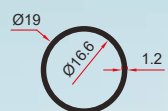

**PRF 0069**

0,834 KG/MT

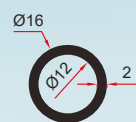

**PRF 0070**

0,240 KG/MT

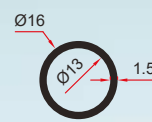

**PRF 0071**

0,185 KG/MT

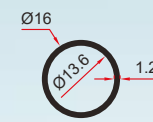

**PRF 0072**

0,155 KG/MT



**PRF 0073**

0,267 KG/MT



# CAM BAZA ÜST PROFİLLER

## GLASS BASE TOP PROFILES

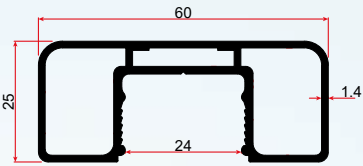

**PRF 0034**

0,834 KG/MT

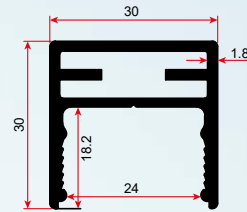

**PRF 0031**

0,658 KG/MT

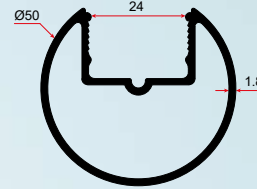

**PRF 0056**

RUBBER 16,5 MM

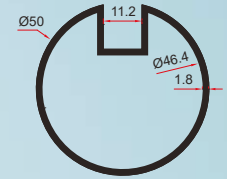

**PRF 0055**

RUBBER 12,5 MM

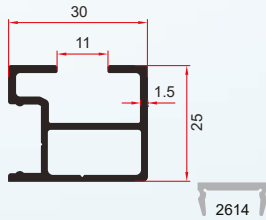

**PRF 0041**

0,490 KG/MT



**PRF 0042**

0,090 KG/MT



**PRF 0032**

0,190 KG/MT

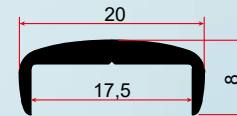

**PRF 0033**

0,140 KG/MT

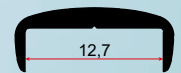

**PRF 0039**

0,113 KG/MT

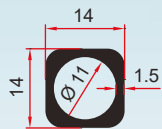

**PRF 0022**

0,251 KG/MT

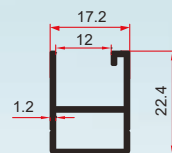

**PRF 0037**

0,254 KG/MT

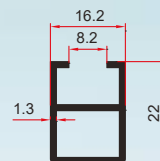

**PRF 0038**

0,267 KG/MT

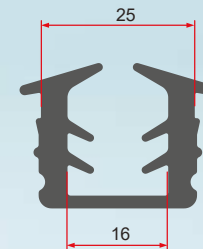

**PRF 0035**

RUBBER 12,5 MM

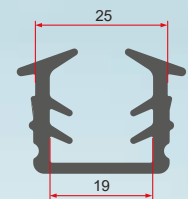

**PRF 0036**

RUBBER 16,5 MM

# PLEKSİ GRUBU

## PLEXIGLASS GROUP



AST 90-1328

130'MM PLEXI STRUTS



AST 90-1324

130'MM PLEXI STRUTS



AST 90-1316

130'MM PLEXI STRUTS



AST 90-1302

130'MM PLEXI STRUTS



AST 90-1306

130'MM PLEXI STRUTS



AST 90-1320

130'MM PLEXI STRUTS



AST 90-1304

130'MM PLEXI STRUTS



AST 90-1305

130'MM PLEXI STRUTS



AST 90-1001

100'MM PLEXI STRUTS



AST 90-1011

100'MM PLEXI STRUTS



AST 90-1006

100'MM PLEXI STRUTS



AST 90-1010

100'MM PLEXI STRUTS



AST 90-1018

100'MM PLEXI STRUTS



AST 90-1019

100'MM PLEXI STRUTS



AST 90-1020

100'MM PLEXI STRUTS



AST 90-1021

100'MM PLEXI STRUTS

# PLEKSI GRUBU

## PLEXIGLASS GROUP



AST 90-4004

40'MM PLEXI STRUTS



AST 90-4003

40'MM PLEXI STRUTS



AST 90-4001

40'MM PLEXI STRUTS



AST 90-4002

40'MM PLEXI STRUTS



AST 90-4011

40'MM PLEXI STRUTS



AST 90-4012

40'MM PLEXI STRUTS



AST 90-4013

40'MM PLEXI STRUTS



AST 90-4014

40'MM PLEXI STRUTS



AST 90-4006

40'MM PLEXI STRUTS



AST 90-4007

40'MM PLEXI STRUTS



AST 90-4008

40'MM PLEXI STRUTS



AST 90-4009

40'MM PLEXI STRUTS



AST 90-4015

40'MM PLEXI STRUTS



AST 90-4005

40'MM PLEXI STRUTS



AST 90-4018

40'MM PLEXI STRUTS



AST 90-4019

40'MM PLEXI STRUTS



metal & alüminyum

Dudullu OSB DES 110 Sok. D:26 Blok  
No:19 Ümraniye / İstanbul  
Tel: +90 (216) 314 35 52  
E-Mail: [export@abirmetal.coö](mailto:export@abirmetal.coö)